

Resolution, Accuracy and Repeatability

Accuracy — For a specific point of interest in three-dimensional space, accuracy is the difference between the actual position in space and the position as measured by a measurement device. Stage accuracy is influenced by the feedback mechanism (linear encoder, rotary encoder, laser interferometer), drive mechanism (ball screw, lead screw, linear motor), and trueness of bearing ways. The measurement reference for Aerotech linear products is a laser interferometer.

Repeatability — Repeatability is defined as the range of positions attained when the system is repeatedly commanded to one location under identical conditions. Uni-directional repeatability is measured by approaching the point from one direction, and ignores the effects of backlash or hysteresis within the system. Bi-directional repeatability measures the ability to return to the point from both directions. Many vendors specify repeatability as \pm (resolution). This is the repeatability of any digital servo system as measured at the encoder. All of Aerotech's specifications, which include the effects of Abbe error, friction, etc. are based on actual operating conditions and usage – not on theoretical, unachievable values.

Resolution — The smallest possible movement of a system. Also known as step size, resolution is determined by the feedback device and capabilities of the motion system. Theoretical resolution may exceed practical resolution. For example, in a ball-screw-based positioning system, a theoretical resolution of 4 nm can be obtained by combining a 4 mm/rev screw, 1000-line encoder, and an x1000 multiplier. The actual motion system will never be able to make a single 4 nm step due to friction, windup, and mechanical compliance. Therefore, the practical resolution is actually less. All of Aerotech's specifications are based on practical resolution.

*Low Accuracy
Low Repeatability*

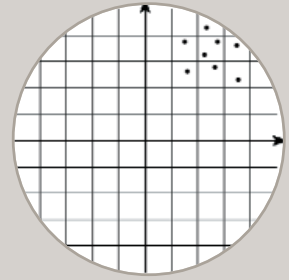

*Low Accuracy
High Repeatability*

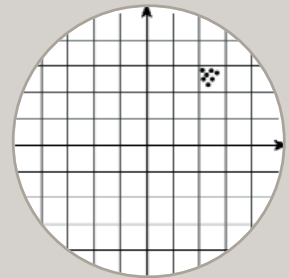

*High Accuracy
High Repeatability*

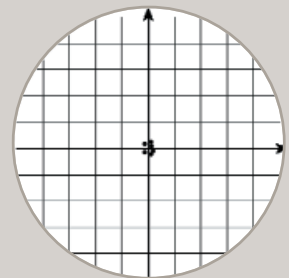

Fine Resolution

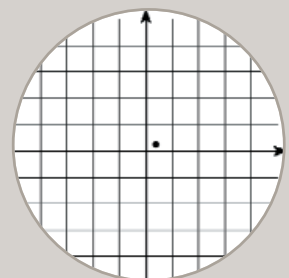

Coarse Resolution

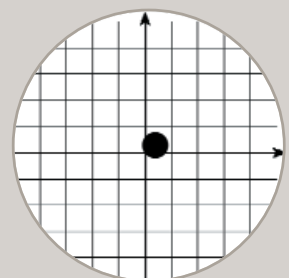

Linear Stage Terminology

There are many factors that affect the capabilities of a linear stage to position accurately in three-dimensional space. Abbe errors, straightness, flatness, pitch, roll, yaw, hysteresis, backlash, orthogonal alignment, encoder errors, mounting surface, and cantilevered loading all contribute to positioning errors in three-dimensional space.

Note: The Specification tables in this catalog contain values for stage positioning accuracy. This specification reflects the positioning capabilities of the stage in the direction of travel only. These values should not be taken as a representation of the positioning capabilities of the stage in three-dimensional space when configured as part of a multi-axis configuration. When two or more positioning stages are assembled in a multi-axis configuration, additional factors will cause positioning errors in three-dimensional space.

For discussion purposes, the following sections will reference a set of two translation stages assembled into an X-Y assembly. The lower stage in the assembly is aligned so that the stage travels in a horizontal plane in the X-axis direction in three-dimensional space (X-axis). The upper stage is assembled on the first stage and travels in a horizontal plane in the Y-axis direction in three-dimensional space (Y-axis).

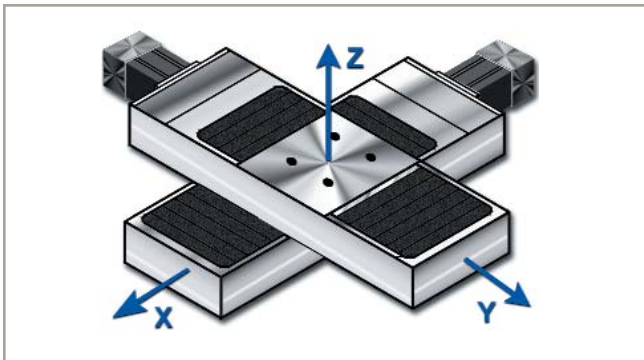

Abbe Error — Displacement error caused by angular errors in bearing ways and an offset distance between the point of interest and the drive mechanism (ball screw) or feedback mechanism (linear encoder).

Straightness — Straightness is a deviation from the true line of travel perpendicular to the direction of travel in the horizontal plane. For the stage assembly listed above, a straightness deviation in the travel of the X-axis stage will cause a positioning error in the Y direction. A straightness deviation in the travel of the Y-axis stage will cause a positioning error in the X direction.

Flatness (a.k.a. vertical straightness) — Flatness is a deviation from the true line of travel perpendicular to the direction of travel in the vertical plane. For the stage assembly shown, a flatness deviation in the travel of the X-axis or Y-axis stage will cause a positioning error in the Z direction.

Pitch — Pitch is a rotation around an axis in the horizontal plane perpendicular to the direction of travel. If the position of interest being measured is not located at the center of rotation, then the pitch rotation will cause an Abbe error in two dimensions. For the X-axis, a pitch rotation will cause an Abbe error in both the X and Z direction. For the Y-axis, a pitch rotation will cause an Abbe error in both the Y and Z direction. The magnitude of these errors can be determined by multiplying the length of the offset distance by the sine and 1-cosine of the rotational angle.

Example: X-axis

$$\begin{aligned}
 \text{Pitch Angle } (\Phi) &= 10 \text{ arc sec } (.0027^\circ) \\
 \text{Offset Distance } (D) &= 25 \text{ mm } (1 \text{ in}) \\
 \text{Error } \cdot \text{ direction} &= D \cdot (1 - \cos (.0027^\circ)) \\
 &= 25 \text{ mm} \cdot (1 - \cos (.0027^\circ)) \\
 &= 0.00003 \mu\text{m} \\
 \text{Error } z \text{ direction} &= D \cdot \sin \Phi \\
 &= 25 \text{ mm} \cdot \sin (.0027^\circ) \\
 &= 1.18 \mu\text{m}
 \end{aligned}$$

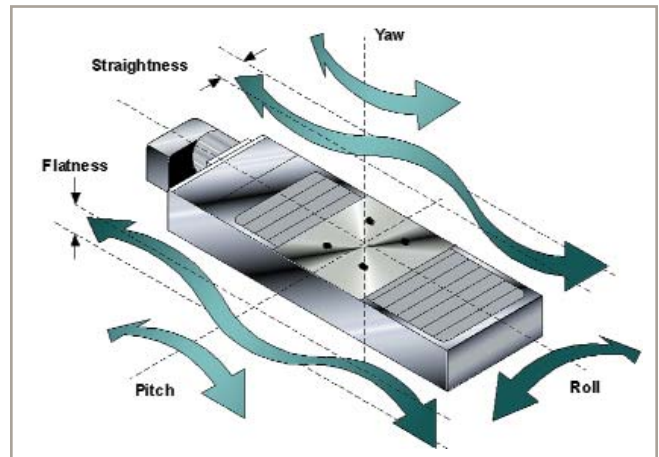

Roll — Roll is a rotation around an axis in the horizontal plane parallel to the direction of travel. If the position of interest being measured is not located at the center of rotation, then the roll rotation will cause an Abbe error in two dimensions. For the X-axis, a roll rotation will cause an Abbe error in both the Y and Z direction. For the Y-axis, a roll rotation will cause an Abbe error in both the X and Z direction. The magnitude of these errors can be calculated by multiplying the length of the offset distance by the sine and cosine of the rotational angle.

Linear Stage Terminology

Yaw — Yaw is a rotation around an axis in the vertical plane perpendicular to the direction of travel. If the position of interest being measured is not located at the center of rotation, then the yaw rotation will cause an Abbe error in two dimensions. For X- or Y-axis stages, yaw rotation will cause an Abbe error in both the X and Y direction. The magnitude of these positioning errors can be calculated by multiplying the length of the offset distance by the sine and cosine of the rotational angle.

Hysteresis Error — Hysteresis error is a deviation between the actual and commanded position at the point of interest caused by elastic forces in the motion system. Hysteresis also affects bi-directional repeatability. Accuracy and repeatability errors caused by hysteresis for Aerotech linear positioning stages are included in the stage specification tables. Elastic forces in the machine base, load, and load coupling hardware are not accounted for and must also be examined and minimized for optimal performance.

Backlash Error — Backlash error is an error in positioning caused by the reversal of travel direction. Backlash is the portion of commanded motion that produces no change in position upon reversal of travel direction. Backlash is caused by clearance between elements in the drive train. As the clearance increases, the amount of input required to produce motion is greater. This increase in clearance results in increased backlash error. Backlash also affects bi-directional repeatability. Accuracy and repeatability errors caused by backlash for Aerotech linear positioning stages are accounted for in the stage specification tables. Linear motor-based stages are direct drive and therefore have zero backlash.

Encoder Error — Imperfections in the operation of the encoder such as absolute scale length, non-uniform division of the grating scale, imperfections in the photo-detector signal, interpolator errors, hysteresis, friction, and noise can affect the positioning capabilities of the linear translation stage. The accuracy and repeatability information in the specification tables takes all of these errors into account except absolute scale length. Absolute scale length is affected by thermal expansion of the encoder scale. Temperature considerations must be accounted for during system design and specification.

Orthogonal Alignment — For the two stages to travel precisely along the X and Y axes, the line of travel for the Y-axis must be orthogonal to the line of travel of the X-axis. If the two travel lines are not orthogonal, Y-axis travel creates a position error in the X direction. The maximum value of this error can be determined by multiplying the travel length of the stage by the sine of the angular error.

Example:

$$\begin{aligned}
 \text{Orthogonality Error} &= 5 \text{ arc sec } (0.0014^\circ) \\
 \text{Travel Length } (L) &= 400 \text{ mm } (16 \text{ in}) \\
 \text{Error} &= L \cdot \sin \theta \\
 &= 400 \text{ mm} \cdot \sin (0.0014^\circ) \\
 &= 9.8 \mu\text{m}
 \end{aligned}$$

Machine Base Mounting Surface – The machine base plays an important role in the performance of the linear translation stage. Aerotech stages typically require that the surface of the machine must have a localized flatness deviation of less than 5 μm (0.0002 in) to guarantee the stage specification. Mounting the stage to a machine base with flatness deviations greater than the specification can deflect the stage. Distortion in an Aerotech translation stage can cause pitch, roll, yaw, flatness, and straightness deviations greater than the specifications listed.

Cantilevered Loading – When a cantilevered load is placed on a translation stage, moment loads are created. Shear and bending forces induce deflection in the stage structural elements. In an X-Y assembly, the cantilevered load, acting on the lower axis, increases as the load traverses to the extremes of the upper axis. A position error in the Z direction occurs due to a combination of Y-axis deflection and X-axis roll.

Rotary Stage Terminology

There are many factors that affect the ability of a rotary stage to perform accurately. Axis of rotation error motions, hysteresis, backlash, encoder errors, mounting surface quality and applied loads all contribute to the quality and performance of a rotary stage or spindle. The following discussion defines and explains these errors in greater detail, as well as some other pertinent nomenclature relating to rotary stages and spindles.

Axis of rotation error motion – An error motion of a rotary stage’s axis of rotation is defined as a change in position, relative to the reference coordinate axes, of the surface of a perfect workpiece, as a function of rotation angle, with the workpiece centerline coincident with the axis of rotation. From this point forward, axis of rotation error motion is designated as “error motion”.

Runout (TIR) – Runout is defined as the total displacement measured by an indicator sensing against a moving surface or moved with respect to a fixed surface. Runout is not an error of a rotary stage’s axis of rotation. The runout of a rotary stage includes errors in setup (e.g., centering errors) and roundness errors of a tabletop, workpiece or measurement artifact. If you can physically put an indicator on a surface, you are measuring the runout of that surface and not an error motion.

Note – To measure an error motion of a rotary stage, the runout of a surface (typically a measurement artifact) needs to be measured. Setup errors and workpiece/artifact errors are removed during post-processing and the result is the error motion(s) of the rotary stage under test. Aerotech specifies rotary stage axis of rotation performance using three main error motion types – tilt, axial and radial error motion. For certain rotary stages or spindles, these error motions are broken down further into subsets such as synchronous and asynchronous error motions. Unless otherwise specified, the error motion values reported in the

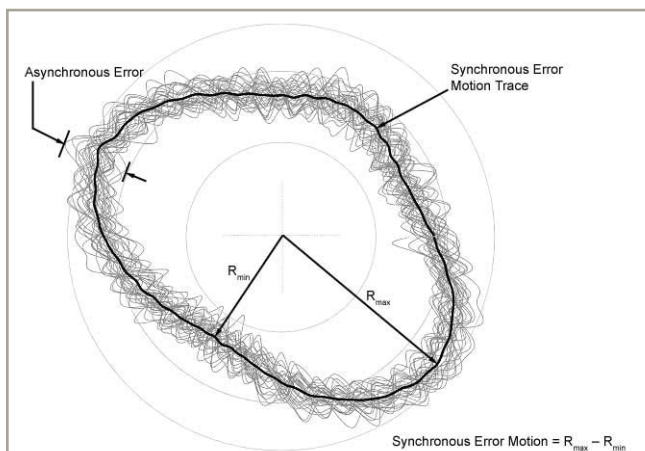

Figure 1: Graphical representation of synchronous and asynchronous error motion.

specification tables are the total error motion of the rotary device.

Synchronous error motion – Synchronous error motion is defined as the component of the total error motion that occurs at integer multiples of the rotation frequency. The term “average error motion” is equivalent, but no longer a preferred term. For example, if N revolutions of data are collected, then the synchronous error motion is calculated first by averaging N readings at each discrete angular position. Then, the peak-to-valley number of all average readings at every angular position is reported as the synchronous error motion (refer to Figure 1).

Asynchronous error motion – Asynchronous error motion is defined as the component of the total error motion that occurs at noninteger multiples of the rotation frequency. Asynchronous error motion comprises those components of error motion that are: (i) not periodic, (ii) periodic but occur at frequencies other than the rotation frequency and its integer multiples, and (iii) periodic at frequencies that are subharmonics of the rotation frequency. Asynchronous error is what remains after the synchronous portion is removed from the total error motion value. The largest peak-to-valley number at each measured angular position is reported as the asynchronous error of the rotary stage under test (refer to Figure 1). In certain industry segments, the term nonrepeatable runout (or NRRO) is used in place of asynchronous error motion.

Total error motion – Total error motion is defined as the complete error motion as recorded by the displacement indicator. Referring to Figure 1, it would be the maximum radius less the minimum radius including both the synchronous and asynchronous terms.

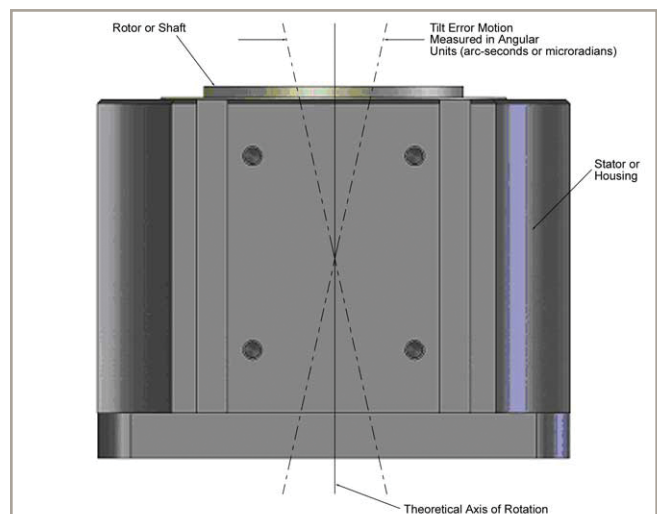

Figure 2: Tilt error motion illustration.

Rotary Stage Terminology

Tilt error motion — Tilt error motion is defined as the error motion in an angular direction relative to the rotary stage axis of rotation (see Figure 2). In previous specification tables published by Aerotech, the term “wobble” was used and is synonymous; however, “wobble” is no longer preferred. Tilt error motion is reported as an angular value (arc-seconds, microradians, etc.).

Axial error motion – Axial error motion is defined as error motion that occurs coaxial with the rotary stage axis of rotation (see Figure 3). Axial error motion is not to be confused with tabletop or shaft end runout.

Radial error motion – Radial error motion is defined as error motion that occurs perpendicular to the rotary stage axis of rotation at a specified axial location (see Figure 4). Unless otherwise specified, Aerotech measures radial error at an axial location of 50 mm above the tabletop or shaft end.

Hysteresis error — A deviation between the actual and commanded position at the point of interest caused by elastic forces in the motion system. Hysteresis also affects bi-directional repeatability. For Aerotech rotary stages, accuracy and repeatability errors caused by hysteresis are accounted for in the stage specification tables. Elastic forces in the machine base, load and load coupling hardware must also be examined and minimized for optimal performance.

Backlash error — An error in positioning caused by the reversal of travel direction. Backlash is the portion of commanded motion that produces no change in position upon reversal of travel direction. Backlash is caused by clearance between elements in the drive train. As the clearance increases, the amount of input required to produce motion is greater. This increase in clearance results

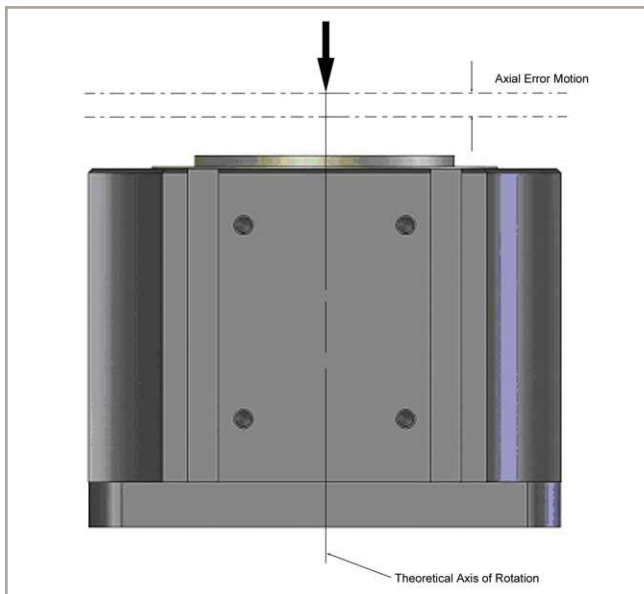

Figure 3: Axial error motion illustration.

in increased backlash error. Backlash also affects repeatability. Unidirectional repeatability refers to the repeatability when approached from the same direction. It does not take into account the effects of backlash. Bidirectional repeatability specifies the repeatability when approached from any direction and includes the effects of backlash. Aerotech controllers have the capability to correct for backlash, if required. All of Aerotech’s direct-drive tables exhibit zero backlash error.

Encoder error — Imperfections in the operation of the encoder such as non-uniform division of the grating scale, encoder grating runout, imperfections in the photodetector signal, interpolator errors, hysteresis, friction and noise can affect the positioning capabilities of the rotary stage. For a rotary stage, the accuracy and repeatability information in the specification tables takes all of these errors into account.

Mounting surface quality – For the rotary stage or spindle to perform to the specifications listed in the catalog, the mounting surface(s) need to be flat. Consult an Aerotech applications engineer for the appropriate tolerance(s) required for each specific rotary stage or spindle.

Applied loads – When a load is placed on a rotary stage or spindle, deflection occurs due to the finite compliance of the structure and bearings. The amount of deflection is dependent upon the applied load and the structural stiffness of the stage and mounting surfaces. Depending on the application, this applied load may cause a deflection that is detrimental to the process. Consult an Aerotech applications engineer if the applied load is large or if there is concern about load-induced errors on the rotary stage or spindle.

Reference: ANSI/ASME B89.3.4M, *Axes of Rotation – Methods for Specifying and Testing*

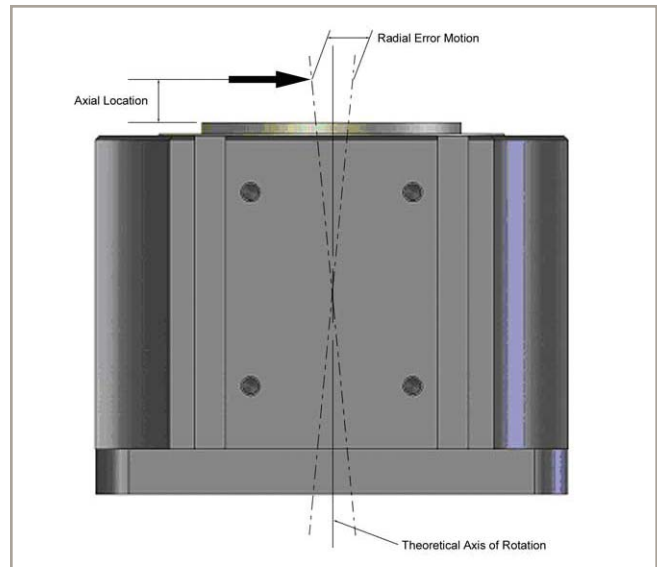

Figure 4: Radial error motion illustration.

Metrology, Testing and Certification

Every stage that is marked with the Aerotech certified symbol is carefully tested in Aerotech's state-of-the-art metrology lab. The positioning stage or system is certified to meet or exceed the specifications outlined in the catalog. Detailed performance characterization plots are supplied with the system. All equipment is set up and tested with the actual controllers and drivers that ship with the system. In the event that only mechanics are purchased, all stages are tested with appropriate controllers and drivers.



The specifications listed in this catalogue and quoted for systems are the actual values derived by testing under working conditions. All non-certified specifications should be considered approximate and represent typical values. Testing is conducted in a vibration-isolated, environmentally controlled lab at 20°C ±1°C. All catalog specifications are generated on a "per axis" basis.

Linear Stages

The standard specifications certified for linear stages are straightness, flatness, accuracy, and bi-directional repeatability. Plots are provided for each axis showing the values of the specifications along the entire travel range of the stage. Linear stages are mounted to a granite base or mounting fixtures that have a ±0.0002 inch flatness geometrical tolerance. Straightness, flatness, accuracy, and repeatability are measured using a laser interferometer and the respective optics and retroreflectors. Unless otherwise noted, testing is performed at a height of 1.75" above the stage under a no-load condition.

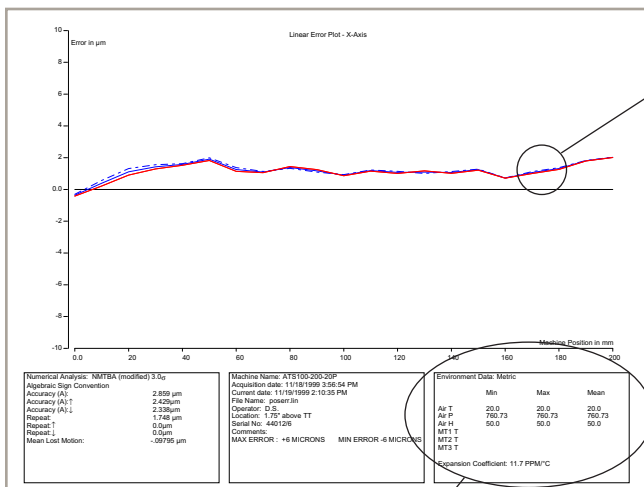

Environmental data is sampled and recorded, ensuring accurate data. Numerical analysis provides a summary of stage characteristics.

HALAR

High accuracy versions of most stages are available and are specified as the HALAR option. HALAR stages are optimized for the highest levels of performance and are then error mapped. For systems provided with Aerotech controllers, the calibration file is preconfigured on the controller. For third-party controllers that have error mapping capability, the calibration file is provided as an ASCII text file.

Rotary Stages

The standard specifications certified for rotary stages are accuracy, repeatability, wobble, and orthogonality for two-axis gimbal mounts. All standard testing for rotary stages is performed using an autocollimator. Plots are provided for each axis.

Alternate Testing

Non-standard testing is available and will be quoted per customer requirements. Some examples of non-standard testing are: pitch, yaw, roll, velocity stability, and dynamic straightness. Pitch and yaw testing is done using an autocollimator.

Special testing is available for multi-axis systems to characterize performance in the assembled configuration, at the actual working height with a simulated load. Please consult the factory for more information and pricing.

Accuracy and bidirectional repeatability plotted along the entire travel range providing a detailed characterization of the stage.

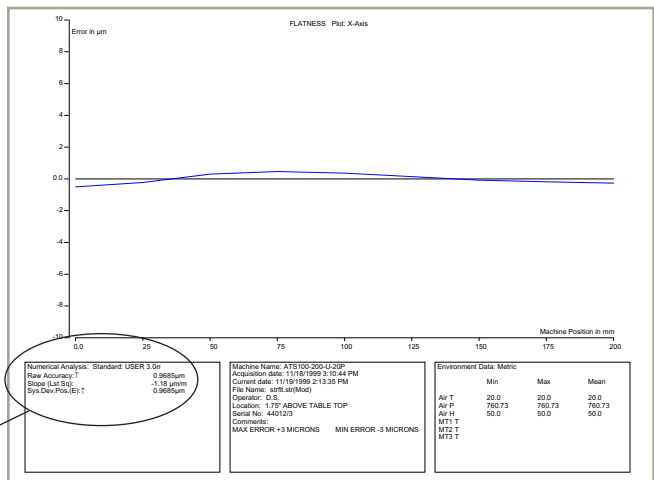

Cantilevered Loading

All maximum load values in the stage specification tables are based on the stage operating in a normal loading condition. A normal loading condition results when the load is attached to the stage with the center of gravity positioned directly above the bearings. The resultant gravity force vector acts downward on the support bearings and has a moment arm of zero.

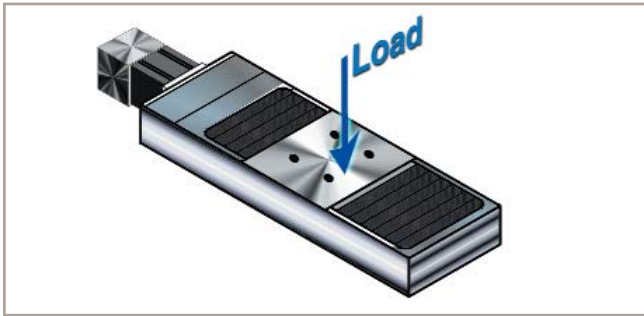

A cantilevered loading condition results when the load is attached to the stage with the center of gravity not acting directly on the support bearings. In this configuration, the load acts on a moment arm and applies unequal loading to the support bearings. Aerotech has further divided the cantilever loading condition into two subsets, a side loading condition (L_{SC}) and a vertical loading condition (L_{VC}).

Side Loading Conditions

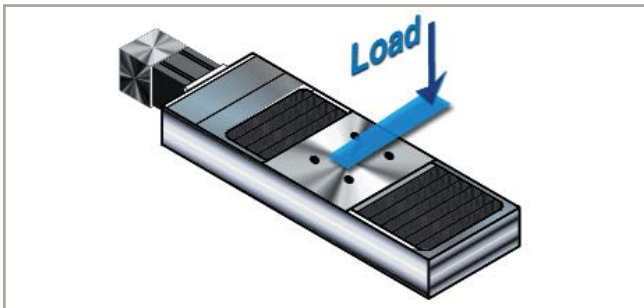

1) The stage tabletop is oriented in the horizontal plane, travel is in the horizontal direction, and the center of gravity is situated off to one side of the tabletop with the moment arm perpendicular to the direction of travel. This configuration is a side loading condition (L_{SC}).

2) The stage tabletop is oriented in the vertical plane, the load is attached directly to the tabletop, and travel is in the



horizontal direction. This configuration is a side loading condition (L_{SC}).

Vertical Loading Conditions

1) The stage tabletop is oriented in the vertical plane, the load is attached directly to the tabletop, and travel is in the vertical direction. This is a vertical loading condition (L_{VC}).

2) The stage tabletop is oriented in the horizontal plane, travel is in the horizontal direction, and the center of gravity is situated beyond the tabletop with the moment arm parallel to the direction of travel. This configuration is a vertical loading condition (L_{VC}).



Cantilevered Load Ratings

When the load on the stage tabletop results in one of the loading conditions specified before, the maximum load carrying capability of the stage is reduced. To determine the new load carrying capability of the stage, two factors must be known: the mass of the load, and the length of the moment arm that the center of gravity acts upon. This can be determined by measuring the distance from the payload center of gravity to the center of the stage tabletop.

In the specification section for each stage, Aerotech has supplied a cantilevered loading chart. These charts are similar to the example cantilevered loading chart shown on the right.

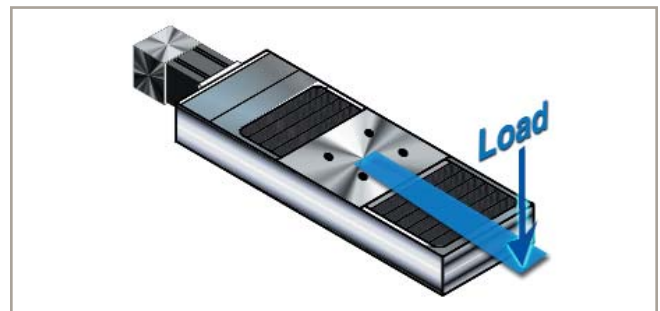

Cantilevered Loading CONTINUED

The cantilevered loading chart shows the relationship between the offset distance of the center of gravity and the maximum possible load for each of the two loading conditions.

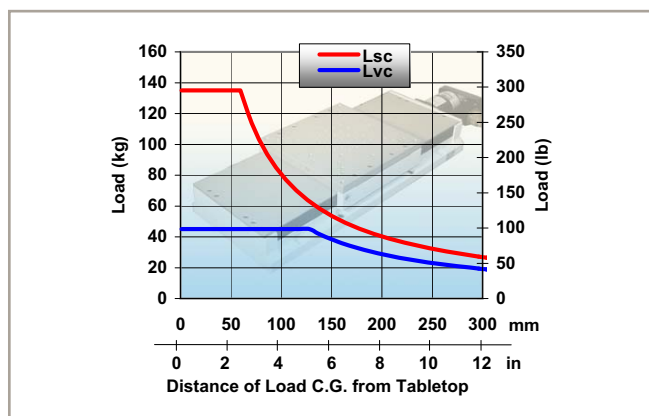
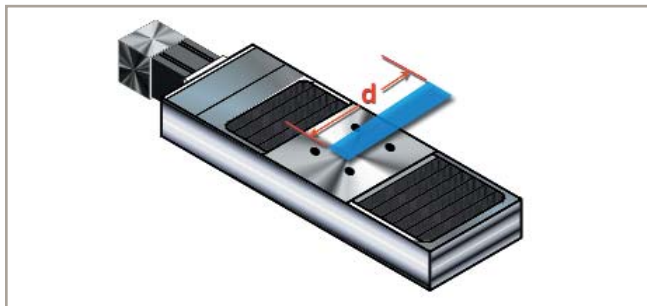

Loading versus Lifetime

Ball Bearing and Linear Ball Bearing Stages

Load capacity and life expectancy for ball bearing and linear bearing stages are inversely related. As the load on the stage increases, the life expectancy of the stage will decrease.

To calculate the life of a stage for a particular applied load (AL) in a normal loading condition, determine the maximum loading (ML) capability of the stage and then determine the loading percentage (LP) of the stage.

$$LP = AL \div ML * ALC * 100\%$$

Where:

ALC = 1.0 for smooth operation with no shocks

ALC = 1.5 for shock operating conditions

Locate the applicable loading percentage on the vertical axis and read the corresponding life (in millions of inches travel) from the horizontal axis. This is the expected life of the stage for the applied load (AL).

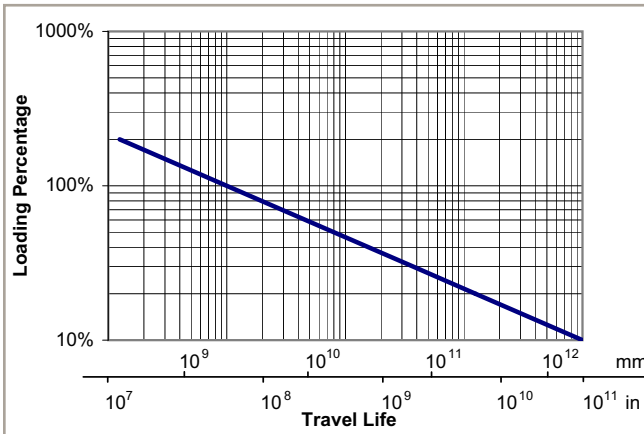

Air Bearing Stages

Since Aerotech air bearings have no contacting elements, they have a virtually unlimited life. Care must be taken to ensure that the stage is operated with adequate air pressure.

To protect the stage against under-pressure, Aerotech recommends an in-line pressure switch. This is typically a 5 V TTL level signal and is tied to the controller E-stop input.

Air supply must be clean, dry to 0° dewpoint, and filtered to 0.25 μm or better. Nitrogen is recommended at 99.9% purity. Typical operating pressure is 80 psi, regulated to ±5 psi.

Computing Resolution

Ball-Screw-Driven Linear Translation Stage With Rotary Encoder

To determine the machine resolution (R) of a linear translation stage with a ball screw and an amplified sine output rotary encoder, the following information is required:

- P The pitch of the ball screw [expressed in mm/rev (in/rev)]
- C The number of pulses per rev of the rotary encoder (encoder pulses/rev)
- MF The multiplication factor of the MXH multiplier (pulses/encoder cycle)
- Q Multiplication factor resulting from the controller (counts/pulse)

Note: MF = 1 for line driver output encoders

Note: All Aerotech controllers perform quadrature on encoder signals; therefore Q = 4

Once all of this information is available, the following equation can be used to determine linear resolution.

$$R = P \div C \div MF \div Q$$

EXAMPLE:

- P = 4 mm per rev
 C = 1000 cycles per rev
 MF = 10 pulses/cycle
 Q = 4 counts per pulse
 R = 4 (mm/rev), 1000 (cycles/rev),
 10 (pulses/cycle), 4 (counts/pulse)
 R = 0.0001 mm/count
 R = 0.1 μ m per count

Ball Screw or Linear Motor Driven Linear Translation Stage with Linear Encoder

To determine the machine resolution R of a linear translation stage with an amplified sine output linear encoder, the following information is required:

- GP The grating pitch (distance travelled in one complete electrical cycle) of the encoder (LT and LE encoders – 20 μ m per cycle, LNencoder – 4 μ m per cycle).
- MF The multiplication factor of the MX multiplier (# pulses/encoder cycle)
- Q Multiplication Factor resulting from the controller (counts/pulse)

Note: For encoders specified as LTxxX5, MF = 5; LTxxX50, MF = 50

Note: All Aerotech controllers perform quadrature on encoder signals; therefore Q = 4.

Once all of this information is available, the following equation can be used to determine linear resolution:

$$R = GP \div MF \div Q$$

EXAMPLE:

- GP = 20 μ m per cycle (LT encoder)
 MF = 50 pulses/cycle
 Q = 4 counts per pulse
 R = 20 (μ m/cycle) \div 50 (pulses/cycle) \div
 4 (counts/pulse)
 R = 0.1 (μ m/count)

Rotary Stage with Encoder

To determine the machine resolution (R) of a worm gear driven rotary stage with an amplified sine output rotary encoder, the following information is required:

- TT Tabletop travel (360 $^{\circ}$ /ttrev)
- WGR Worm gear ratio [number of motor revolutions required for one tabletop revolution(mrev/ttrev)]
- C The number of cycles per revolution of the rotary encoder (encoder cycles/rev)
- MF The multiplication factor of the MXH multiplier (number pulses/encoder cycle)
- Q Multiplication factor resulting from the controller (counts/pulse)

Note: WGR = 1 for direct drive tables

Note: MF = 1 for line driver output encoders

Note: All Aerotech controllers perform quadrature on encoder signals; therefore Q = 4

Once all of this information is available, the following equation can be used to determine rotary resolution:

$$R = TT \div WGR \div C \div MF \div Q$$

EXAMPLE:

- TT = 360 $^{\circ}$ /ttrev
 WGR = 54 (mrev/ttrev)
 C = 1000 cycles per rev
 MF = 1 pulse/cycle (no multiplier)
 Q = 4 counts per pulse
 R = 360 ($^{\circ}$ /ttrev), 54 (mrev/ttrev),
 1000(cycles/mrev), 1 (pulse/cycle),
 4 (counts/pulse)
 R = 0.00166 $^{\circ}$ /count or 6.0 arc sec/count

Computing Maximum Data Rate

In the specification section for each stage, Aerotech has included a maximum datarate chart. These charts are similar to the example maximum travel speed chart shown below.

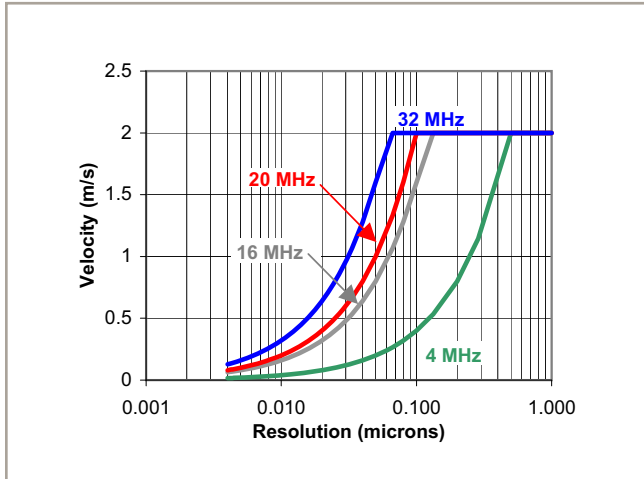

The maximum travel speed chart shows the relationship between resolution and travel speed of the stage. To use these charts, first determine the resolution of the translation stage and locate this value on the X-axis of the maximum travel speed chart. Determine the data input rate of the motion control system and then move vertically to the intersection of the appropriate graph line on the maximum travel speed chart. Determine the value for the Y-axis at this intersection. This value is the maximum travel speed that may be attained without exceeding the system data rate.

ALTERNATIVE METHOD:

To calculate the maximum theoretical speed (MTS) that a system can obtain, the following information is required:

- R Resolution of the stage ($\mu\text{m}/\text{count}$ or arc sec/count)
- DR Data input rate of the system (counts/second)

Once this information is obtained, the following equation can be used:

$$\text{MTS} = \text{DR} \cdot \text{R}$$

EXAMPLE:

UNIDEX 100 stand-alone motion controller with 0.1 micron resolution linear translation stage:

$$\begin{aligned} \text{DR} &= 4 \text{ MHz} = 4000000 \text{ (counts/second)} \\ \text{R} &= 0.1 \text{ } (\mu\text{m}/\text{count}) = 0.0001 \text{ (mm/count)} \\ \text{MTS} &= 4000000 \text{ (counts/second)} \cdot 0.0001 \text{ (mm/count)} \\ \text{MTS} &= 400 \text{ mm/second} \end{aligned}$$

CAUTION:

To allow for system variances and the potential for velocity overshoot, the top commanded speed (TCS) should be ten percent less than the maximum Theoretical Speed (MTS) to prevent undesirable system performance.

For the previous example:

$$\begin{aligned} \text{TCS} &= \text{MTS} \cdot 0.9 \\ \text{TCS} &= 400 \text{ (mm/s)} \cdot 0.9 \\ \text{TCS} &= 360 \text{ mm/s} \end{aligned}$$

For high resolution, high velocity applications, the overall system data rate must not be exceeded.

Laser Interferometer Implementation

Laser interferometers represent the ultimate feedback device for high-precision motion control application. The combination of high resolution and outstanding accuracy has made it the ideal transducer for wafer steppers, flat panel inspection, and high-accuracy laser micromachining.

A laser interferometer system employs a highly stabilized light source and precision optics to accurately measure distances. Interferometers are superior to glass encoders for several reasons. The most obvious advantage is that interferometers have greater inherent accuracy and better resolution. An additional advantage is that interferometers measure distances directly at the workpiece. Due to mounting considerations linear encoders are often “buried” inside the positioning stage, some distance away from the workpiece introducing an additional source of error. A well-designed interferometer system is able to take measurements directly at wafer height, maximizing accuracy.

Theory of Operation

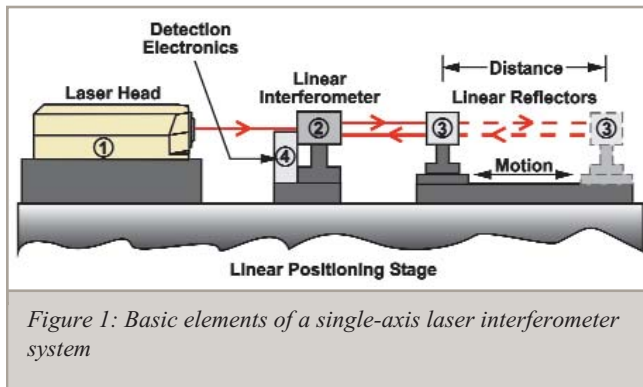

Aerotech’s LZR3000 series laser interferometer system is based on the Michelson interferometer. It is composed of (refer to Figure 1): (1) a light source, in this case a frequency stabilized He-Ne laser tube; (2) a linear interferometer optic which is made by the combination of a polarizing beam-splitter and retroreflector; (3) a moving linear retroreflector; and (4) detection electronics. When the laser light reaches the interferometer optic, it is separated into two distinct beams (Figure 2). The first beam is reflected back to the detectors and is used as a reference beam. The second beam passes through the optic and is reflected off a moving retroreflector to provide the measurement beam. Due to the motion of the moving retroreflector, the second beam undergoes a shift caused by relative motion of the beam. When the reference beam and measurement beam recombine, they create an interference pattern.

The interference fringe appears as a dark and bright pattern (Figure 3). The intensity of this pattern is a sinusoidal

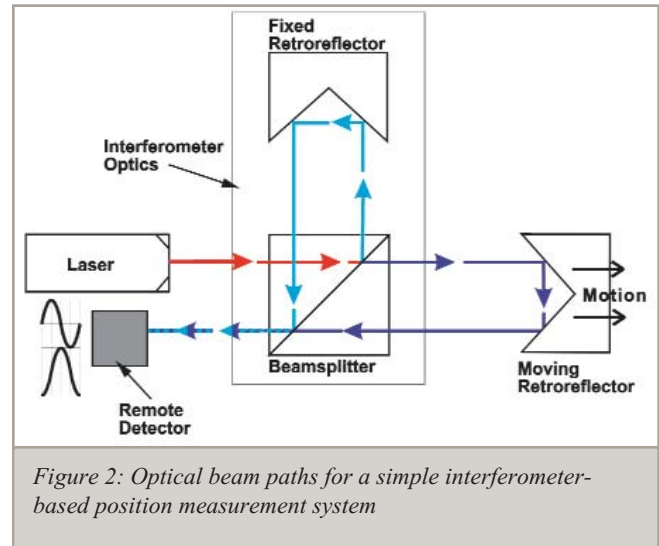

signal that can be treated similar to a standard A-quadrant-B encoder signal. Aerotech’s standard MXH series high-resolution multiplier is capable of multiplication up to $\times 1024$. Since the fundamental wavelength (λ) of the laser light is 633 nm, and the signal output to the multiplier electronics is $\lambda/2$, the effective resolution of the system can be as low as 0.3 nm when utilizing a retroreflector-based system. Two-dimensional systems, which utilize plane mirror optics instead of retroreflectors, benefit by an optical doubling effect which improves the maximum resolution to 0.15 nm.

There are two basic approaches to the detector electronics. The simplest method is to incorporate the detector in the same housing as the laser. This provides a compact system and is best suited for single-axis applications. For multi-axis applications, use of a remote detector is highly recommended. Aerotech’s LZR series remote detection systems embed the detection photodiodes in the same housing as the interferometer optics for optimal beam stability. When coupled with appropriate beam-splitting optics, this allows one laser head to be used as the source for multiple axes. This is useful for XY systems, or systems with active yaw control. Not only does purchasing a single laser source reduce the cost of the laser system, but valuable footprint space is saved as well.

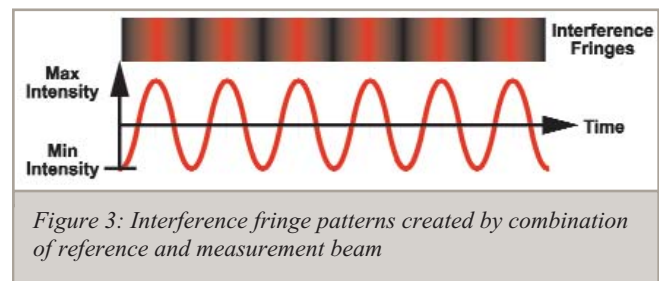

Laser Interferometer Implementation CONTINUED

Interferometer Implementation

A typical dual-axis implementation is illustrated in Figure 4. To ensure that a beam path is provided at all locations throughout stage travel, two-dimensional implementations require the use of plane mirror optics. The plane mirror implementation has the added benefit of optically doubling the laser signal, resulting in a fundamental resolution of $\lambda/4$. A single laser source is split to provide a signal to all axes of measurement, which in this example are the X and Y axes. These beams are steered to the interferometer optics and plane mirrors prior to their measurement at a remote detector. The detector electronics are located in the same housing as the interferometer optics, providing a compact solution. Some existing laser interferometer solutions require a signal processing board that interfaces directly to the motion controller. In many cases this is done so as to provide a parallel word directly to the motion controller, which allows for high data rates. While this may be required in high-speed, high-resolution applications, this solution has the distinct disadvantage of making the laser interferometer a proprietary, closed-architecture solution. Interfacing to both the interferometer board and motion controller requires an in-depth knowledge of both devices that is often impractical for most users.

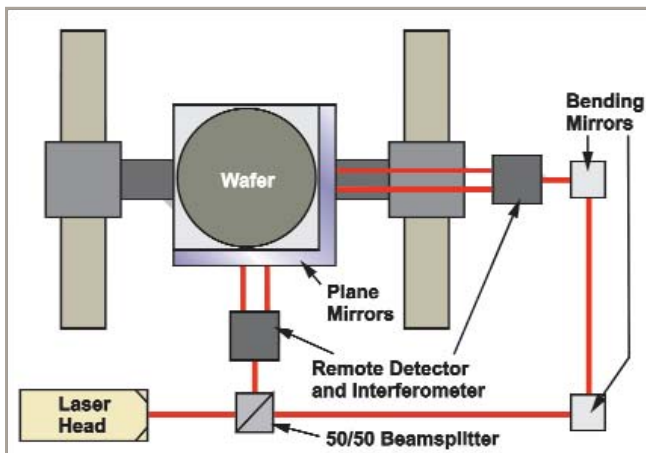

Figure 4: Dual-axis implementation using single laser source and remote detectors

Advances in motion controller technology have nearly made this approach obsolete. Aerotech LZR series laser interferometer output signals are standard A-quad-B, and are electrically identical to the output of a traditional incremental encoder. To the motion controller, the interferometer appears to be a standard feedback device, simplifying system implementation. Aerotech's UNIDEX® family of stand-alone and PC-bus-based controllers employ high-speed devices, resulting in serial data rates as high as 32 MHz. For a system with a resolution of 6 nm, that

results in a speed of nearly 200 mm/s. While Aerotech also manufactures a laser interferometer signal processing board for high-speed applications, the need for this approach has been greatly minimized and often the much simpler serial approach proves to be the optimal solution.

While the position feedback may be straightforward to process, there are other important considerations that must be made when implementing a laser interferometer-based system. Issues such as home-marker implementation, losses of feedback signal, and error-source reduction require unique solutions in an interferometer-based system.

Since the interferometer is strictly an incremental device, there is no way to establish an accurate home reference. Traditional home devices such as LVDTs and optical proximity switches are only adequate in establishing an approximate home. For accurate wafer measurements, it is often necessary to acquire a fiducial directly from the wafer to establish a sufficiently accurate and repeatable home. Once the mark is acquired, the motion controller counters can be reset to zero (software homed) and the processing continues.

When implementing a laser interferometer as a feedback device it is absolutely necessary for the interferometer to provide a “beam blocked” signal. Unlike a linear encoder that places the read head in close proximity to the encoder glass, it is easy to block the feedback signal (in this case the laser beam) in an interferometer system. This condition requires the motion controller to immediately generate a fault condition and disable the axes. Aerotech's UNIDEX controller and LZR series interferometer implement all fault handling automatically, greatly simplifying system operation.

Minimize Potential Error Sources

The same requirements that necessitate the use of a laser interferometer – high resolution and high accuracy – require that system-wide error sources be minimized. While it is inherently more accurate than alternate feedback schemes, without proper understanding of the error sources, it will be no more effective than a low-cost linear encoder. Environmental conditions, mechanical design and optical alignment must be considered in the design/implementation of any high-accuracy laser interferometer based motion system.

Environmental Errors

The wavelength of light emitted by a He-Ne laser is by definition equal to 632.99072 nm in a vacuum. Interferometer accuracy in a vacuum is accurate to ± 0.1

Laser Interferometer Implementation CONTINUED

ppm. However, most applications require operation of the system in atmospheric conditions, so this accuracy degrades. The index of refraction of air effectively changes the frequency of the laser light which appears as a path length difference. Fortunately, the effects of temperature, pressure and humidity as they affect the wavelength of light are well known and are related by Edlen's equation. As a result, the LZR series interferometer systems incorporate a "weather station" that samples the environmental conditions. These signals are digitized and processed to create a wavelength scale number that is used to generate a correction factor. An environmentally corrected system will have an accuracy ± 1.5 ppm or better. The final accuracy is largely a function of the stability of the environmental conditions.

Environmental Effects on Accuracy

Temperature:	1 ppm / 1°C
Pressure:	1 ppm / 2.5 mm Hg
Humidity:	1 ppm / 85% change

The most effective, and incidentally also the most expensive, means of compensating for changes in the refractive index of air is by utilization of a wavelength tracker. Also known as a refractometer, a wavelength tracker measures the relative change in the refractive index of air. Because it is a relative measure only, initial environmental conditions must be known and computed to establish an initial wavelength scale factor. The wavelength tracker is a purely optical device that is highly accurate, but is only used in very high-end applications due to its high cost.

Mechanical Vibration and Air Turbulence

Mechanical vibration or air turbulence can cause perturbations in the positioning feedback system that will limit overall system performance. Mechanical vibration errors can be minimized through proper design of the machine base vibration isolation system. Thermal gradients across the beam path are created due to turbulence in the air so careful design of the machine micro-environment is critical to sub-nanometer performance. A simple and effective means of minimizing these effects is to "shield" the beam by placing a tube around the system or simply by minimizing the flow of air.

Mechanical Errors

For truly cutting edge performance, an XY system must utilize a high-performance positioning system made up of air bearings mounted to a granite base. Air-bearing stages, with their superior geometrical characteristics, are highly recommended for all laser interferometer based systems, while the granite provides an extremely flat reference surface as well as good thermal stability. Without

outstanding linear stages as the basis of operation, Abbe errors will drastically undermine the accuracy of the laser measurement system. Abbe errors are linear displacement errors that are caused by an angular deviation in the axis of motion. A properly designed system will place the center of the measurement mirror as close to the work piece as possible. By tracking the motion of the actual part under test, as opposed to the stage itself, the effect of any pitch / yaw deviations is vastly reduced. When combined with a linear stage system that is inherently geometrically accurate, Abbe errors are nearly eliminated.

Dead-Path Error

A less obvious source of error occurs as a result of both the environment and mechanical placement of the optics. This error is known as dead-path error and is caused by portions of the beam that are effectively uncompensated (Figure 5). While the moveable reflector translates throughout the measurement path, environmental compensation electronics compute and correct for the change in the index of refraction of air. The dead path is a distance that the laser beam travels where it undergoes no relative motion. Since the environmental compensation scheme only corrects for relative motion, this distance remains uncorrected. If uncorrected, the dead-path error effectively moves the zero point (X_0) of the system as the environmental conditions change. There are several means of addressing this, but the most straightforward ones are to compensate for the error or eliminate it. Software compensation for the dead path error requires an additional calculation to be performed that not only accounts for temperature, pressure and humidity, but for the dead-path distances as well. Mechanical compensation entails separating the interferometer's retroreflector from the beam-splitter by a distance equal to the dead-path error. As a result, both the measurement beam and reference beam have equal dead-paths that cancel each other out. This approach requires careful alignment of the optics and assumes that the environmental conditions are identical for both dead-paths.

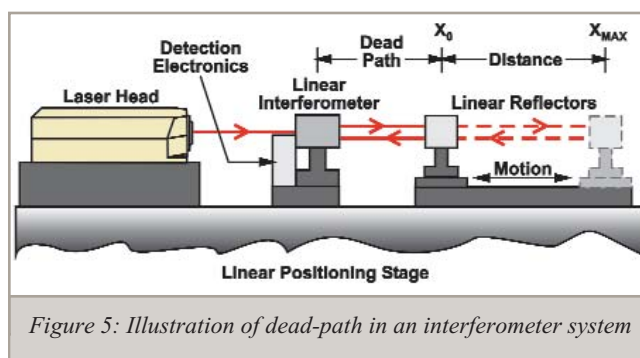

Figure 5: Illustration of dead-path in an interferometer system

Laser Interferometer Implementation

Elimination of the dead-path requires that the linear interferometer optics be placed as close to the zero point of the moveable reflector as possible. As a rule of thumb, when the optics are placed within 50 mm of each other, the error due to dead-path is negligible.

Alignment Errors

Assuming that the mechanical sub-system is sound, and environmental correction is properly implemented, the final pieces to the puzzle are the optics themselves and their alignment. All optics have inherent inaccuracies in the form of optical non-linearity. This error cannot be controlled by the user, and is a function of the quality of the optics. All interferometer optics will have some amount of nonlinearity, so this error cannot be completely eliminated but is minimized by the use of high quality optics, such as the ones provided by Aerotech.

An optical error that can be controlled by the user is a misalignment that is commonly known as cosine error. Cosine error occurs when the laser beam path and the axis of stage motion are not completely parallel. The relationship is best modeled as a triangle where the laser beam represents one leg of the triangle, and the actual motion is the hypotenuse (Figure 6). This error can be minimized through careful alignment of the optics to the stage.

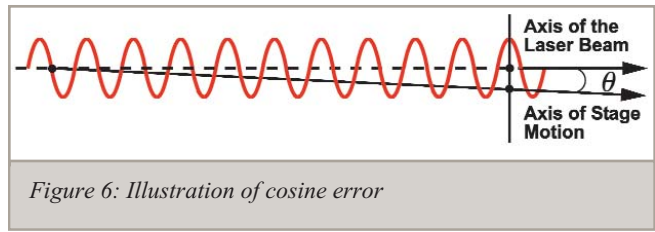

The Aerotech Vacuum Advantage

Aerotech's vast application experience, unmatched product scope, and extensive engineering capabilities make us the partner of choice for vacuum-compatible motion systems. Since its inception, Aerotech has designed and manufactured the highest-performance motion control and positioning systems available, and our vacuum-compatible platforms are no exception. Aerotech's precision motion control products provide the critical performance for today's demanding vacuum applications in markets such as semiconductor manufacturing and inspection, optics fabrication, and military/aerospace.

Always guiding our vacuum system development effort is Aerotech's motto: "*Dedicated to the Science of Motion.*" This means that Aerotech is constantly developing motion control products and services that provide:

- **The lowest cost of ownership**
- **Highest throughput**
- **Highest accuracy**
- **Best return on investment**

A wide variety of standard Aerotech motion products are available in vacuum-prepared versions. In addition to standard platforms, Aerotech routinely manufactures custom systems designed to meet application specific needs. All Aerotech's vacuum compatible motion platforms minimize pump downtime, chamber contamination, and

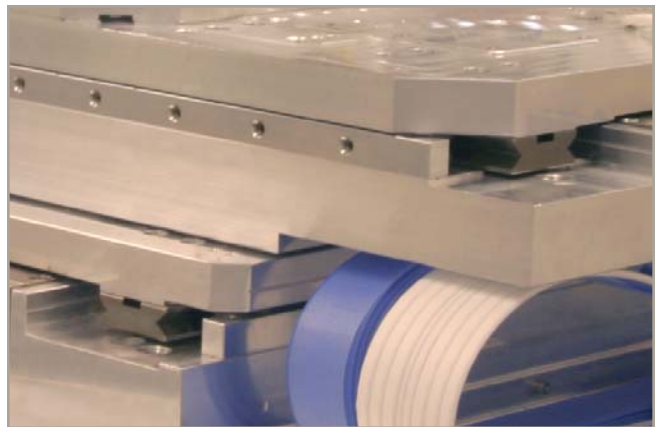
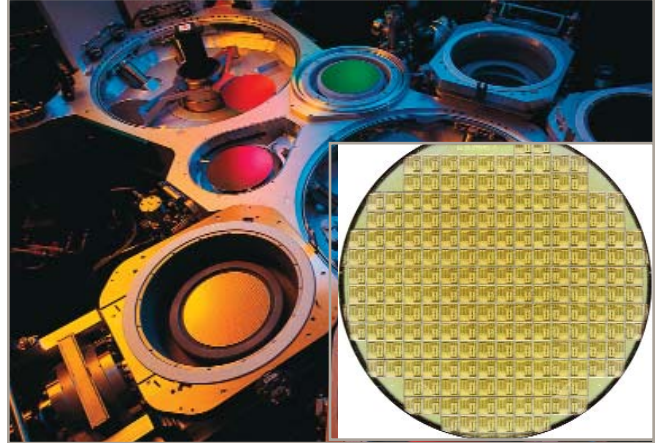

XY linear motor driven motion system showing several key design elements that allow stage operation in high vacuum.

Aerotech Has Specific Experience with Vacuum-Compatible Motion Platforms

- **Material selection**
- **Surface preparation**
- **Hardware venting and elimination of trapped volumes**
- **Lubricant selection**
- **Thermal management**
- **Magnetic field control**
- **Cleaning**
- **Bakeout**
- **Handling and packaging**

Aerotech's Vacuum Experience Includes a Wide Variety of Applications

- **EUV Lithography**
- **Scanning Electron Microscopy (SEM)**
- **Ion-Beam Profiling**
- **E-Beam Inspection**
- **Ion implantation**
- **Deposition**
- **Satellite Component Testing**
- **Optics Polishing**

Vacuum Preparation

thermal issues. In addition, these systems can incorporate key application considerations like reduction of magnetic fields.

Vacuum options available from Aerotech:

- **Low Vacuum Option (10^{-3} torr)**
- **Standard Vacuum Option (10^{-6} torr)**
- **High Vacuum Option (10^{-8} torr)**

Most Aerotech stage products are available with modifications for either low vacuum (10^{-3} torr) or standard vacuum (10^{-6} torr) use. Custom designs are available that are certified to high vacuum (10^{-8} torr).

Material Selection

Because acceptable materials vary according to vacuum level, application, operating temperature, etc., Aerotech offers a broad array of options that control total mass loss (TML) and collectible volatile condensable materials (CVCVM). For key design components, Aerotech does the following:

- **Lubricants:** Low vapor pressure lubricants are selected to be compatible with the vacuum level and the customer's process (e.g., elimination of hydrocarbons).
- **Cable Management System (CMS):** CMS construction and materials typically utilize Teflon® insulated wires (MIL-C-27500) along with specialized electrical connectors that utilize a variety of materials including PEEK™. Other cable and connectorization options are available depending on the application requirements.
- **Surface Finish:** Surface finish options include bare aluminum, electroless nickel, or vacuum-compatible paint (Aeroglaze Z306).



Star Tracker Tester. Standard vacuum (10^{-6} torr) AOM360 series gimbal mount.

- **Hardware:** Systems use vented stainless-steel fasteners for all blind holes and all potential air traps are vented.

Aerotech has always worked very closely with our customers to ensure that the system meets or exceeds outgassing requirements.

Thermal Management

Thermal management is key in vacuum systems because they cannot rely on convection for the removal of heat from the motors and bearings. Without thermal management methods, stage performance and life can be reduced from that of an equivalent system operated in atmosphere. This is why Aerotech has put forth a considerable effort in the development of thermal isolation methods and passive and active cooling techniques. These techniques help to maximize conduction modes of cooling and reduce or eliminate heat sources inside the chamber.

Servomotors

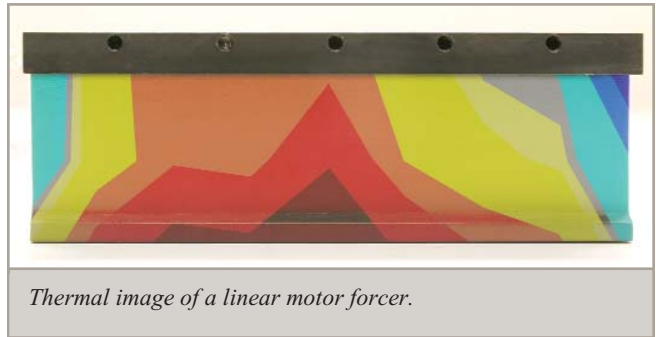

Thermal image of a linear motorforcer.

Design of linear and rotary servomotors is critical to vacuum system operation because they are the primary heat source. This is why Aerotech designs and builds motors to specifically address the issues associated with motors in vacuum. From special materials of construction to magnetic circuit design, Aerotech servomotors are optimized for minimal outgassing, high force/torque per unit volume, and long life.

Magnetic Field Management



Example of a shielded linear servomotor.

Vacuum Preparation

Certain vacuum applications require very low magnitude magnetic fields as well as minimal field fluctuation at the system work point. Existence of either of these conditions can cause process related problems. Aerotech addresses these “AC” and “DC” field issues through use of specialized shielding techniques, special magnet track design, and use of non-magnetic materials. In addition, the mechanical system is designed to keep the motor coils and magnets well away from process work points.

Handling/Cleaning

Handling is critical in maintaining the integrity of a vacuum stage system. Vacuum systems are assembled in Aerotech’s expansive cleanroom by precision assemblers wearing polyethylene, powder free gloves. All parts are thoroughly cleaned to remove oils and other contaminants. Following cleaning, components are packaged in heat-sealed nylon or particle-free polyethylene bags. Where required, component-level bake-out is available.

For more information regarding Aerotech’s Vacuum Advantage, please contact a member of our knowledgeable sales staff.

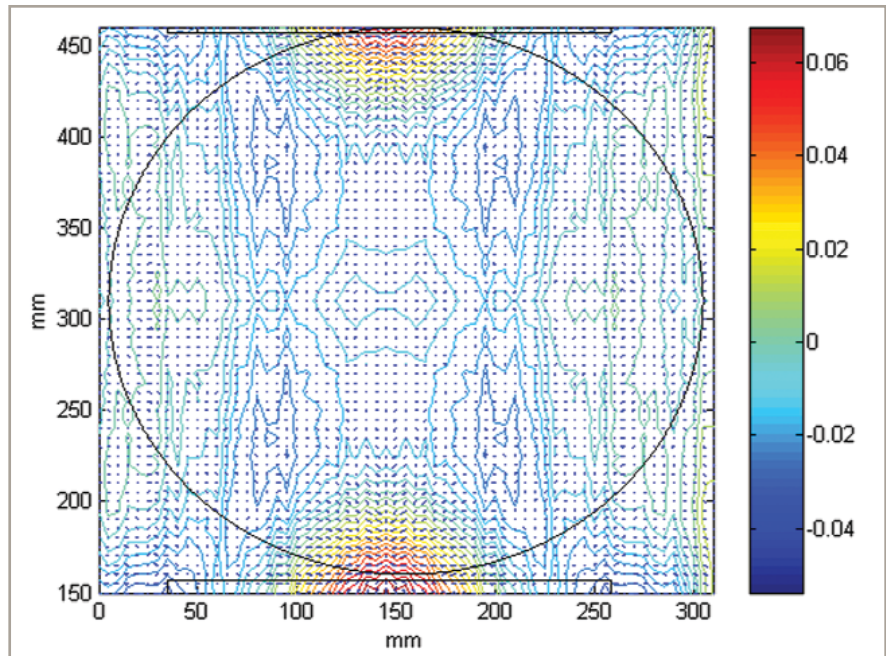

Actual magnetic field measurement over a 300 mm diameter target zone.



Expanded Cleanroom Facility. Aerotech’s expanded cleanroom facility is ISO 14644-1 Class 6 (Federal Standard 209E Class 1000) with cell specific ISO Class 4 (Class 10) capabilities. The large active area includes pre-/post-dressing areas, dedicated product transfer, and large main product assembly areas.

Vacuum Preparation



Vacuum Imaging System. Standard vacuum (10^{-6} torr), 3-axis ball screw system based on Aerotech's ATS2000 series staging.

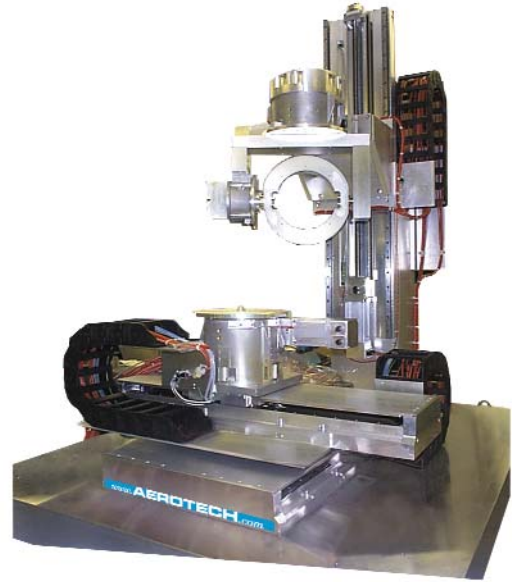

Ion Beam Profiling System. 6-axis coordinated motion system incorporating a high precision, liquid cooled, linear-motor-driven x-y stage. System also includes a 2-axis gimbal with direct shaft-mounted rotary encoder position feedback.



Optics Polishing System. Custom, multi-axis, high-vacuum system using a variety of staging technologies.



Satellite Component Testing. Standard vacuum (10^{-6} torr), 5-axis positioning system incorporating two worm-drive rotary stages and three ball-screw-driven linear stages.

Cleanroom Preparation

Aerotech has a long history of providing components and systems to the semiconductor and medical device manufacturing industries. This experience has provided extensive knowledge of how to prepare stages for cleanroom use. The following provides details about Aerotech's "Best Practices" cleanroom technique:

In general terms, Aerotech does the following:

1. Use cleanroom compatible lubricants (NSK LGU grease, THK AFE-CA, etc.).
2. Use cleanroom compatible cable management systems. Little or no use of plastic cable-carrier-style cable management.
3. Use stainless-steel hardware.
4. Stage surfaces are either anodized or painted.
5. System is fully wiped-down prior to shipment and is packaged using cleanroom compatible bags.

Aerotech does not use stage sealing belts or other devices that are known to actively generate particulates.

The manufacturing process for cleanroom-compatible systems incorporates the following:

1. All component-level machine parts are cleaned ultrasonically or with a lint-free cloth and reagent grade isopropyl alcohol (IPA).
2. All blind holes are wiped or flushed with reagent grade IPA.
3. Parts are dried using pressurized nitrogen. Compressed air is not used.
4. All granite surfaces are cleaned with special granite cleaner that is specified by the manufacturer for this purpose.
5. After final assembly the entire mechanical system is blown off with filtered, dry nitrogen and wiped down with reagent grade IPA.
6. The system is then double-bagged with nitrogen purge.

Please note that the final system cleanliness level will depend on customer handling procedures, system air management methods, etc.

Advanced Manufacturing Facilities

In order to address the increased demand for super-clean motion systems, Aerotech expanded its cleanroom facilities

to include large system ISO 14644-1 Class 6 (Federal Standard 209E Class 1000) and cell specific ISO Class 5 (Class 100) capabilities. The large active area includes pre-/post-dressing areas, dedicated product transfer, and large main product assembly areas.



This clean-room expansion project is just another example of Aerotech's commitment to our customers and their needs. We will continue to advance our capabilities to meet and exceed future customer requirements.



In addition to our cleanroom capabilities, we have constructed dedicated laboratories for our motion control research and development efforts. Each of these laboratories is outfitted with the latest equipment and resources to provide the perfect environment for cutting-edge motion research. This research will continue to make Aerotech products the highest performance motion components and systems available.



Electrostatic Discharge Protection

Electrostatic Discharge (ESD) is a serious threat to electronic devices and integrated circuits. ESD is the sudden and momentary electric current that flows between two objects at different electrical potentials. The most recognizable form of ESD is a spark. Common causes of ESD events are static electricity and electrostatic induction where an electrically charged object is placed near a conductive object that is isolated from ground and then comes in contact with a conductive path.

Electronic devices can suffer permanent damage when subjected to a small ESD and care must be taken with machine design to ensure no charge can build up. Aerotech has a long history of supplying ESD protected precision motion systems to the electronics manufacturing, data storage and semiconductor industries. Protection techniques include:

- Stage surfaces coated in conductive electroless nickel so no charge can build up
- Stage components tied to a common ground to maintain zero potential difference
- Special ESD cable management chains used to maintain long-term conductivity to dissipate electrostatic charges
- Removal of stage sealing belts
- Optional slip-ring for rotary stages to ground the tabletop and customer payload

Given the sensitive nature of electronic devices, many motion systems requiring ESD protection often require cleanroom preparation.

Multi-Axis Assembly

XY Assembly Options

Example: P/N = PA5 - A - 1L - 2U

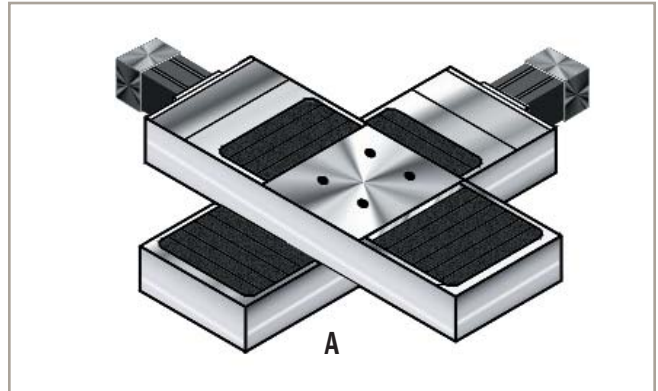
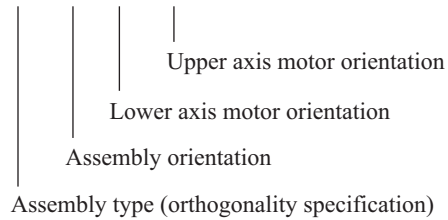

STEP 1: Specify Assembly Type

NPA = Non precision assembly

PA10 = XY assembly; 10 arc sec orthogonality;
alignment to within 7 microns orthogonality for
short travel stages

PA5 = XY assembly; 5 arc sec orthogonality;
alignment to within 3 microns orthogonality for
short travel stages

STEP 2: Specify Assembly Orientation

See drawings on the right. Choose A or B

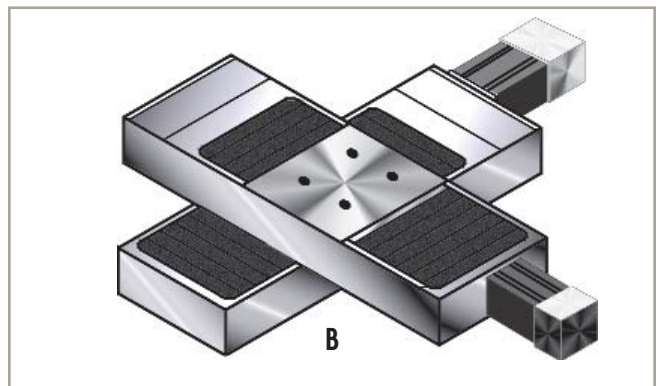

STEP 3: Specify Lower Axis Motor Orientation

Choose from options 0 through 13 (see Motor Orientation Options section). Include "L" after option code. Use option 0 for linear motor stages, or stages with no motor.

STEP 4: Specify Upper Axis Motor Orientation

Choose from options 0 through 13 (see Motor Orientation Options section). Include "U" after option code. Use option 0 for linear motor stages, or stages with no motor.

Multi-Axis Assembly CONTINUED

XZ or YZ Assembly Options

Example: P/N = PA5Z - A - 1H - 2V

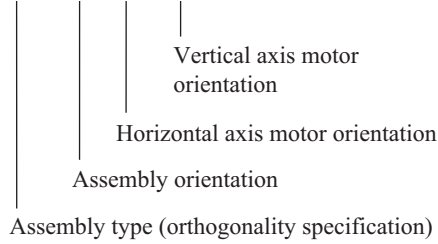

STEP 1: Specify Assembly Type

- NPAZ = Non precision assembly
- PA10 Z = XZ or YZ assembly with L-bracket; 10 arc second orthogonality; alignment to within 10 microns orthogonality for short travel stages
- PA5Z = XZ or YZ assembly with L-bracket; 5 arc second orthogonality; alignment to within 5 microns orthogonality for short travel stages

STEP 2: Specify Assembly Orientation

See drawings on the right. Choose A, B, C, or D.
 Note: Linear motor and belt driven stages cannot be used in the vertical axis.

STEP 3: Specify Lower Axis Motor Orientation

Choose from options 0 through 13 (see Motor Orientation Options section). Include “H” after option code. For XYZ assembly, enter option 0 and specify motor orientation for upper axis of XY assembly. Use option 0 for linear motor stages, or stages with no motor.

STEP 4: Specify Upper Axis Motor Orientation

Choose from options 0 through 13 (see Motor Orientation Options section). Use “V” after option code. Use option 0 for stages with no motor.

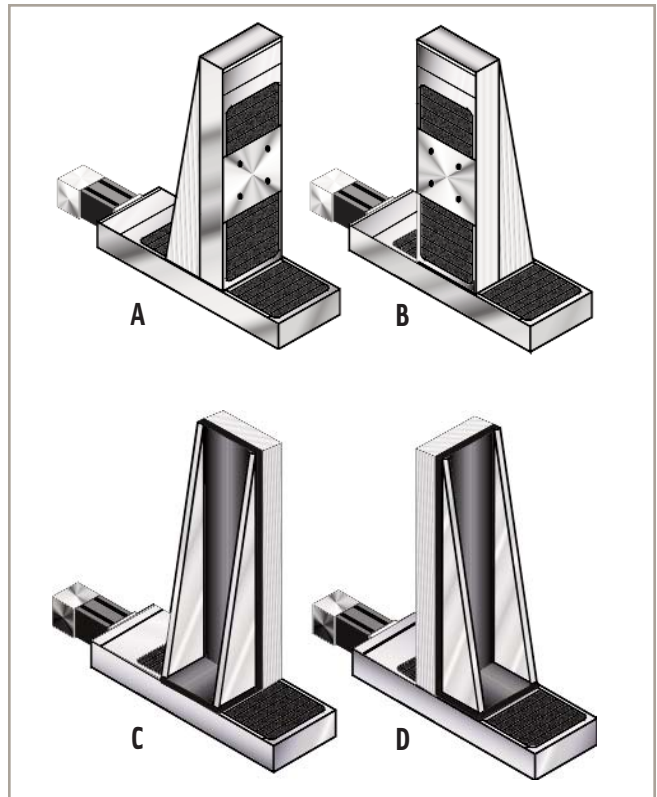

Motor Orientation Options

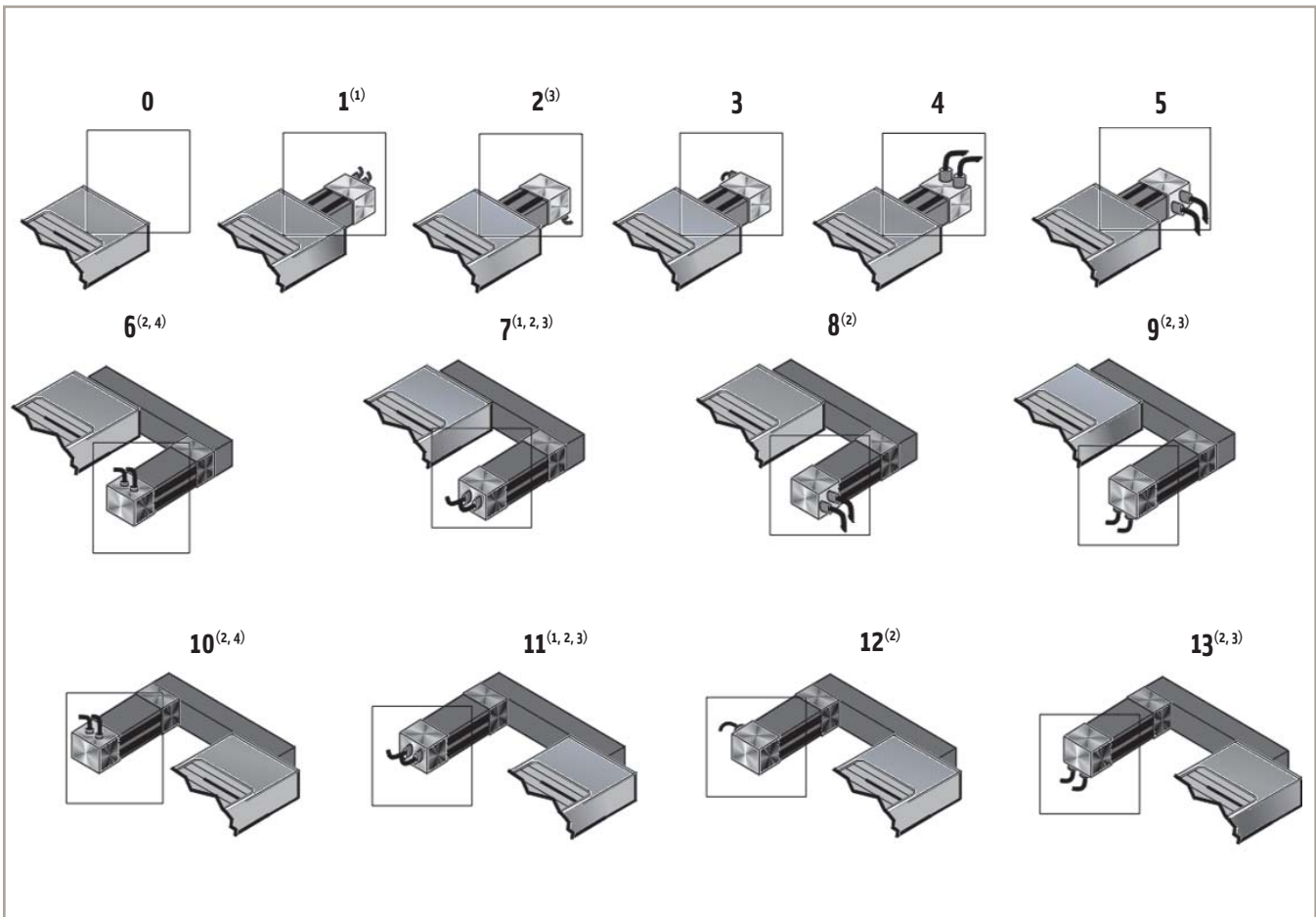

Notes:

1. Available only with NEMA 23 DC servomotors.
2. Requires fold back kit at additional cost. Not available for AT50, AT100, AT300, and AT1500.
3. Not available for lowest axis of assembly.
4. Not available for lower axis of XY assembly.

System Checkout

Parameters Files Set — Each system is configured with a fully functional parameter file including tuning. The parameter file is shipped with every system and greatly reduces system setup time.

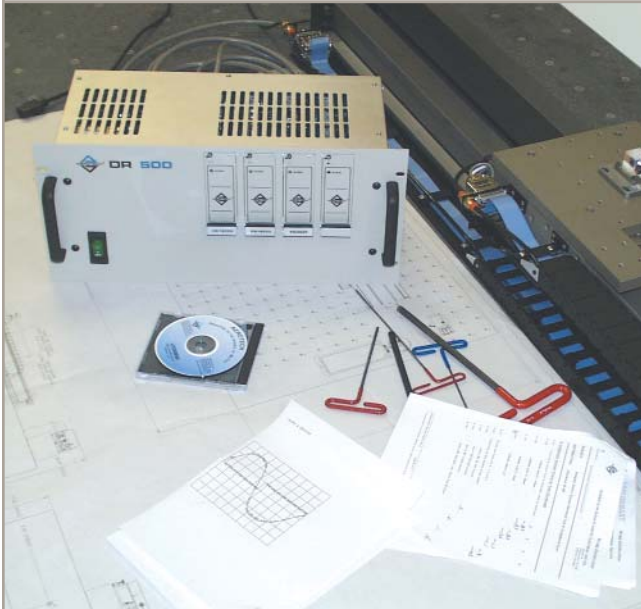

System Plots and Drawings — Interconnect and wiring drawings are included with each system. Also, with Aerotech Certified systems, performance plots are provided for all axes.

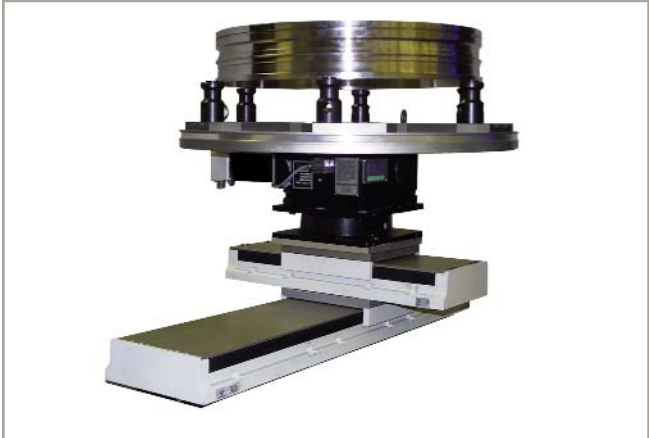
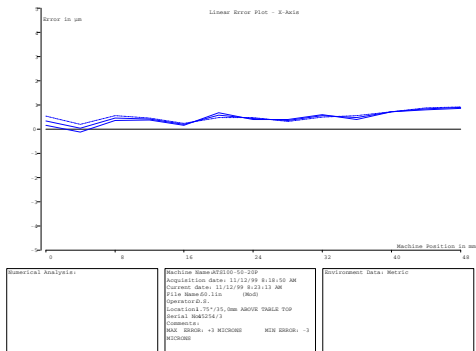

Testing with Custom Load — Aerotech tunes and tests systems with customer-specified loads resulting in optimized systems.

Systems Mounted to Granite — Custom granite bases can be supplied and configured with the system. This allows the system to ship with minimal processing and mounting requirements.



Cabling Fully Connected — All systems are fully integrated with appropriate cabling. Our connector scheme ensures out-of-the-box, plug-and-play operation.

Motor Selection and Sizing

Motor Selection

With each application, the drive system requirements greatly vary. In order to accommodate this variety of needs, Aerotech offers five types of motors.

Linear Motors

Advantages

- Highest acceleration, highest speed
- No backlash, windup or wear
- Brushless – no maintenance

Slotless Motors

Advantages

- Ultra-smooth operation
- Zero cogging
- Brushless – no maintenance

Disadvantages

- Complex amplifier design

Brushless Motors

Advantages

- High acceleration
- High torque
- Brushless – no maintenance

Disadvantages

- More complex amplifier design

DC Servomotors

Advantages

- Smooth operation, low-velocity ripple
- High torque

Disadvantages

- Brushes limit ability to continuously start and stop
- Brushes require maintenance

Microstepping Motors

Advantages

- Simple operation
- High torque at low speeds

Disadvantages

- Open loop
- Low acceleration capability
- More heat generation than servomotors

Motor Sizing Process

The following sections describe how to choose a motor using speed, torque, and inertia selection criteria. The basic procedure for sizing a motor is:

1. Determine move parameters
2. Calculate load inertia (or mass)
3. Calculate peak and rms torque (or force) requirements

While the steps for motor sizing remain constant, different mechanical systems require different formulas to calculate the first three steps. The selection of the motor is determined by the general characteristics of the motor desired and the ability of the motor to meet the calculated requirements.

Motor Sizing Software

Aerotech's Motor Sizing Workbook is now available! This file may be downloaded from Aerotech's web site at www.aerotech.com. The free-of-charge motor sizing sheet features the following application support:

- Linear Motor
- Direct Drive
- Leadscrew
- Beltdrive
- Rack and Pinion

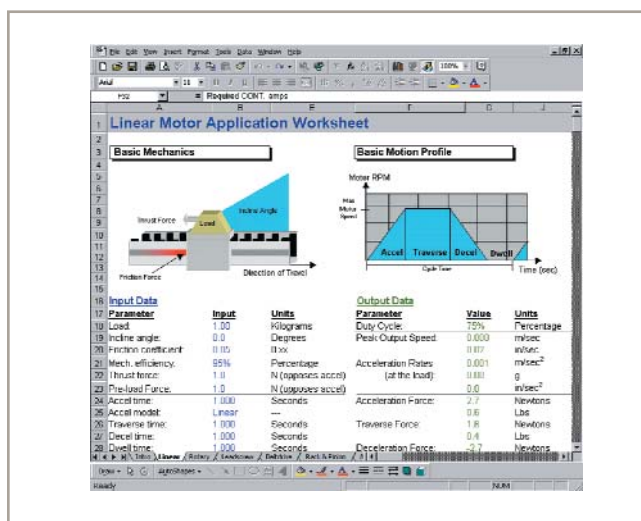

Motor Selection and Sizing CONTINUED

Motion Velocity Profile

The most common and efficient velocity profile for point-to-point moves is the “1/3-1/3-1/3” trapezoid. This profile breaks the time of the acceleration, traverse, and deceleration into three equal segments. The end result is that the profile provides the optimal move by minimizing the power required to complete the move.

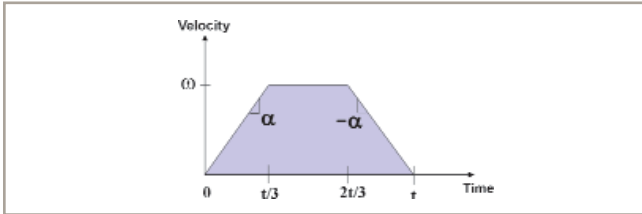

If you know the move distance and time, you can quickly calculate the acceleration and velocity as follows:

Rotary

$$\alpha = \frac{4.5 \theta}{t^2}$$

$$\omega_{\text{avg}} = \frac{\Delta\theta}{\Delta t}$$

$$\omega = 1.5 \frac{\Delta\theta}{\Delta t}$$

where:

- α = acceleration in rad/s²
- θ = distance in radians
- t = total move time in seconds
- ω = peak velocity in rad/s

Linear

$$a = \frac{4.5 x}{t^2}$$

$$v_{\text{avg}} = \frac{\Delta x}{\Delta t}$$

$$v = 1.5 \frac{\Delta x}{\Delta t}$$

- a = acceleration in m/s²
- x = distance in meters
- t = total move time in seconds
- v = peak velocity in m/s

Inertia and Mass

In a rotary motor system, the best load-to-motor inertia match is 1:1 because it minimizes power consumption and increases system stability. Typically, systems will not achieve a 1:1 ratio; ratios as high as 10:1 can exist without adversely affecting system stability. For low bandwidth systems, higher ratios are acceptable but should be avoided due to the effect of decreased system stability.

In a linear motor system, the mass is direct-coupled to the moving coil (forcer). System stability is directly dependent on the stiffness of the mechanics and bandwidth of the servo controller.

Rotary

$$J = J_{\text{motor}} + J_{\text{system}}$$

Linear

$$m = m_{\text{Forcer}} + m_{\text{Load}}$$

Note: The inertia of a rotary system (J_{system}) is dependent on the mechanics of the system. The load in a linear motor system (m_{Load}) is the sum of all weights (kg used as a force) directly connected to the moving forcer coil.

Peak Torque and Peak Force

The total torque that a motor must produce to move itself and the load is:

Rotary

$$T_t = T_\alpha + T_f + T_\omega + T$$

where:

- T_t = total peak torque in N-m
- T_a = acceleration torque in N-m
- T_f = friction torque in N-m
- T_w = viscous torque in N-m
- T_g = gravity torque in N-m

Linear

$$F_t = F_a + F_f + F_g$$

- F_t = total peak force in N
- F_a = acceleration force N
- F_f = friction force in N
- F_g = gravity force in N

A simplified expression for acceleration torque and force that provides a reasonable estimation value is:

Rotary

$$T_\alpha = \frac{J_t \alpha}{e}$$

where:

- T_α = acceleration torque
- J_t = total inertia in kg-m²
- α = acceleration in rad/s²
- e = transmission efficiency

Linear

$$F_a = \frac{m_t a}{e}$$

- F_a = acceleration force
- m_t = total mass in kg
- a = acceleration in m/s²
- e = transmission efficiency

Motor Selection and Sizing CONTINUED

A simplified expression for gravity torque and force that provides a reasonable estimation value is:

Rotary

$$T_g = \frac{0.0016 W}{P e}$$

where:

T_g = gravity torque in N-m

W = weight of load in kg

P = pitch of transmission (rev/mm)

e = transmission efficiency

Linear

$$F_g = m_t g$$

F_g = total force in N

m_t = total mass in kg

g = acceleration from gravity

rms Torque

Obtaining the root-mean-square (rms) value of the required torque in an application is important because the heating of the motor is related to the square of the rms torque output of the motor.

Rotary

$$T_{rms} = \sqrt{\frac{(0.66 T_a^2 + T_f^2 + T_w^2 + T_g^2)t}{t_{on} + t_{off}}}$$

where:

T_{rms} = rms torque in oz-in (using 1/3-1/3-1/3 profile)

T_a = acceleration torque in N-m

T_f = friction torque in N-m

T_w = viscous torque in N-m

T_g = gravity torque in N-m

t_{on} = total move time in seconds

t_{off} = dwell time between moves

Linear

$$F_{rms} = \sqrt{\frac{(0.66 F_a^2 + F_f^2 + F_g^2)t}{t_{on} + t_{off}}}$$

F_{rms} = rms force in N (using 1/3-1/3-1/3 profile)

F_a = acceleration force in N

F_f = friction force in N

F_g = gravity force in N

t_{on} = total move time in seconds

t_{off} = dwell time between moves in seconds

Rotary Motor/Ball Screw Example

The specifications of the system are:

Ball-Screw Data

Diameter:	13 mm
Length:	500 mm
Pitch:	0.5 rev/mm
Efficiency:	90% (ball screw) 40% (lead screw)

Mechanical Data

Friction coefficient (μ):	0.05
Load:	4.5 kg
Orientation:	horizontal

Move Profile

Type:	1/3-1/3-1/3 trapezoid
Distance:	8 mm
Move time:	0.1 s
Dwell time:	0.1 s

Motor

Brushless:	BM75E
------------	-------

STEP 1. Determine move parameters

The peak speed (ω) and acceleration (α) of the motor required can be determined using the formulas:

$$\omega = \frac{1.5 (25.13 \text{ rad})}{0.1 \text{ s}} = \frac{377.0 \text{ rad}}{\text{s}} = 3600 \text{ rpm}$$

$$\alpha = \frac{4.5 \theta}{t^2} = \frac{4.5 (25.13 \text{ rad})}{0.1^2} = 11310.0 \frac{\text{rad}}{\text{s}^2}$$

Note: Verify that both values are within the specifications of the motor.

STEP 2. Determine motor shaft load inertia

The calculation of the inertia is dependent on the mechanics of the system. For the ball screw the inertia can be calculated by:

$$J_{\text{screw}} = (7.57 \times 10^{-13}) D^4 L \quad \text{kg} - \text{m}^2$$

$$J_{\text{screw}} = 7.57 \times 10^{-13} (13 \text{ mm})^4 (500 \text{ mm}) \\ = 1.082 \times 10^{-5} \quad \text{kg} - \text{m}^2$$

where:

J_{screw} = screw inertia in $\text{kg} - \text{m}^2$

D = screw diameter in mm

L = screw length in mm

Motor Selection and Sizing CONTINUED

The inertia of the load using a ballscrew mechanism can be calculated using:

$$J_{\text{load}} = 2.55 \times 10^{-8} \frac{m_{\text{load}}}{P^2} \quad \text{kg} - \text{m}^2$$

$$J_{\text{load}} = 2.55 \times 10^{-8} \frac{4.5}{0.5^2} = 4.59 \times 10^{-7} \quad \text{kg} - \text{m}^2$$

where:

$$J_{\text{load}} = \text{payload inertia (reflected) in kg-m}^2$$

$$m_{\text{load}} = \text{payload in kg}$$

$$P = \text{screw pitch in rev/mm}$$

From the results above, the inertia at the motor shaft is:

$$J_{\text{system}} = J_{\text{screw}} + J_{\text{load}} = 1.08 \times 10^{-5} + 4.59 \times 10^{-7}$$

$$J_{\text{system}} = 1.13 \times 10^{-5} \quad \text{kg} - \text{m}^2$$

A motor that gives a good inertia match and meets the required motor speed of 3600 rpm is the BM75E, with an inertia of:

$$J_{\text{motor}} = 0.52 \times 10^{-5} \quad \text{kg} - \text{m}^2$$

Checking the inertia ratio ($J_{\text{system}}/J_{\text{motor}} = 2.2:1$). The total inertia of the complete system is given by:

$$J_{\text{system}} + J_{\text{motor}} = 1.65 \times 10^{-5} \quad \text{kg} - \text{m}^2$$

Step 3. Calculate peak and rms torque

The acceleration (peak) torque, T_{α} , and friction torque, T_f , are now calculated using the system inertia values. The acceleration torque required can be estimated at:

$$T_{\alpha} = \left(J_{\text{motor}} + \frac{J_{\text{screw}}}{e} + \frac{J_{\text{load}}}{e} \right) \alpha$$

$$T_{\alpha} = \left(0.52 \times 10^{-5} + \frac{1.08 \times 10^{-5}}{0.9} + \frac{4.59 \times 10^{-7}}{0.9} \right) 11310$$

$$= 0.20 \quad \text{N} - \text{m}$$

The BM75E can provide 0.53 N-m of continuous torque and 1.41 N-m peak torque, which is much greater than the system requires. The element of friction torque, T_f , can now be derived using the friction coefficient (μ):

$$T_f = \frac{(W\mu)}{2\pi Pe} = \frac{(4.5)(9.8)(0.05)}{(6.283)(0.5)(1000)(0.90)} = 8.0 \times 10^{-4} \quad \text{N} - \text{m}$$

Total peak torque required of the motor is estimated by:

$$T_t = T_{\alpha} + T_f = 0.20 + 8.0 \times 10^{-4} = 0.20 \quad \text{N} - \text{m}$$

Knowing the total torque, the formula for rms torque is applied and determined to be:

$$T_{\text{rms}} = \sqrt{\frac{[0.66 (0.20)^2 + (8.0 \times 10^{-4})^2] 0.1}{0.2}} = 0.11 \quad \text{N} - \text{m}$$

This is well within the motor's rating of 0.53 N-m.

Motor Selection and Sizing CONTINUED

Linear Motor Sizing Example

The following specifications summarize the system.

Machine Details

Friction coefficient (μ):	0.002
Load:	10 kg
Orientation:	horizontal
Air cooling:	1.36 bar (20 psi)
Carriage/motor mass:	5 kg

Move Profile

Type:	1/3-1/3-1/3 trapezoid
Distance:	350 mm
Move time:	250 ms
Dwell time:	275 ms

STEP 1. Determine move parameters

Using the 1/3-1/3-1/3 model:

$$a_{\text{trap}} = \frac{4.5 \times}{t^2} = \frac{4.5 (0.35 \text{ m})}{(0.25 \text{ s})^2} = 25.2 \frac{\text{m}}{\text{s}^2}$$

$$v = \frac{1.5 \times}{t} = \frac{1.5 (0.35 \text{ m})}{(0.25 \text{ s})} = 2.1 \frac{\text{m}}{\text{s}}$$

Note: Most systems utilize a sinusoidal acceleration profile instead of the more easily modeled trapezoidal for system considerations. Sinusoidal acceleration is modeled as:

$$a_{\text{sine}} = 1.5 (a_{\text{trap}})$$

$$a_{\text{sine}} = 1.5 (25.2 \frac{\text{m}}{\text{s}^2}) = 37.8 \frac{\text{m}}{\text{s}^2}$$

Note: Verify that all values are within the specifications of the system.

STEP 2. Determine moving mass

STEP 3. Calculate peak and rms force

$$m_{\text{total}} = m_{\text{load}} + m_{\text{carriage/motor}}$$

$$m_{\text{total}} = 10 \text{ kg} + 5 \text{ kg} = 15 \text{ kg}$$

Breaking up the move profile into four segments, the fundamental equations for calculating forces during a trapezoidal move are:

1. $F_a = ma + F_f$
2. $F_{\text{trav}} = F_f$
3. $F_d = ma - F_f$
4. Cycle dwell time in seconds

Where:

F_a = force to accelerate the load

F_{trav} = force during traverse motion

F_d = force required to decelerate the load

F_f = force due to friction

ma = mass x acceleration

$$F_a = (ma) = (10 \text{ kg})(25.2 \frac{\text{m}}{\text{s}^2}) = 252 \text{ N}$$

The friction force is determined by:

$$F_f = \mu m_{\text{total}} a_g = (0.002)(15 \text{ kg})(10 \frac{\text{m}}{\text{s}^2}) = 0.3 \text{ N}$$

$$F_{\text{peak}} = F_a = 252 \text{ N} + 0.3 \text{ N} = 252.3 \text{ N}$$

To compute rms or continuous force, dwell time must be known.

Applying the rms force equation from the previous example, F_{rms} is:

$$F_{\text{rms}} = \sqrt{\frac{(F_a)^2(t_a) + F_f^2(t_{\text{trav}}) + (F_d)^2(t_{\text{dec}})}{t_{\text{on}} + t_{\text{off}}}}$$

$$F_{\text{rms}} = \sqrt{\frac{(252.3 \text{ N})^2(83 \text{ ms}) + (0.3 \text{ N})^2(83 \text{ ms}) + (251.7 \text{ N})^2(83 \text{ ms})}{(250 \text{ ms} + 275 \text{ ms})}}$$

$$F_{\text{rms}} = 141.7 \text{ N}$$

The rms force of 142.4 N is used to select a linear motor. In this case, a BLM-203-A can provide up to 232 N of continuous force and 902 N peak force with 1.36 bar (20 psi) forced air cooling.

Miscellaneous Data

Abbreviated Terms

C	= Celsius	min	= minute
cm	= centimeter	mm	= millimeter
F	= Fahrenheit	m	= meter
ft	= foot	nm	= nanometer
g	= gravity or gram (note context)	N	= newton
in	= inch	oz _m	= ounce mass
kg	= kilogram	rad	= radian
kW	= kilowatt	rpm	= revs per minute
lb _f	= pound force	rps	= revs per second
lb _m	= pound mass	s	= seconds
		μm	= micron (micrometer)

Metric Prefixes

NAME	ABBREVIATION	MULTIPLE
Giga	G 10 ⁹	1,000,000,000
Mega	M 10 ⁶	1,000,000
Kilo	k 10 ³	1,000
Hecto	h 10 ²	100
deka	da 10 ¹	10
—	— 10 ⁰	1
deci	d 10 ⁻¹	.1
centi	c 10 ⁻²	.01
milli	m 10 ⁻³	.001
micro	μ 10 ⁻⁶	.000001
nano	n 10 ⁻⁹	.000000001

Material Densities

	oz/in ³	lb/in ³	g/cm ³
aluminum	1.57	0.098	2.72
brass	4.96	0.31	8.6
bronze	4.72	0.295	8.17
copper	5.15	0.322	8.91
plastic	0.64	0.04	1.11
steel	4.48	0.28	7.75

Mechanism Efficiencies

ball screw	0.9
lead screw	0.4
spur gear	0.6
timing belt/pulley	0.9

Friction Coefficients

linear bearings	0.002
air bearings	0.0

Miscellaneous

$^{\circ}\text{F} = (1.8 \times ^{\circ}\text{C}) + 32$ $^{\circ}\text{C} = .555 (^{\circ}\text{F} - 32)$
 acceleration constant (g) = $386 \text{ in/s}^2 = 32.2 \text{ ft/s}^2 = 9.8 \text{ m/s}^2$
 1 psi = 14.5 bar

Miscellaneous Data CONTINUED

Useful Formulae

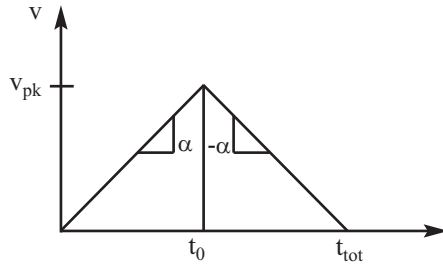

From $t = 0$ to $t = t_0$:

$$x = \frac{1}{2}at^2 \quad a = \frac{2x}{t^2} \quad x = \frac{1}{2}(t_0)(v_{pk})$$

From $t = t_0$ to $t = t_{tot}$:

$$x = -\frac{1}{2}at^2 \quad a = \frac{-2x}{t^2} \quad x = \frac{1}{2}(t_{tot} - t_0)(v_{pk})$$

where:

- x = distance
- a = acceleration
- v_{pk} = peak velocity

Inertia Calculations

$$J_{\text{screw}} = 7.57 \times 10^{-13} D^4 L \quad \text{kg-m}^2$$

where:

- D = screw diameter in mm
- L = screw length in mm

Load inertia reflected through a screw

$$J_{\text{load screw}} = 2.55 \times 10^{-8} \frac{m}{p^2} \quad \text{kg-m}^2$$

where:

- m = payload in kg
- p = screw pitch in rev/mm

$$J_{\text{disk}} = 1.6 \times 10^{-6} L \rho R^4$$

where:

- L = length of disk in mm
- r = density of disk in kg/mm^3
- R = radius of disk in mm

Load inertia reflected through a gearpass

$$J_{\text{load geared}} = \frac{J_{\text{load}}}{N^2}$$

where:

- N = gear ratio R_2/R_1 (motor/load)

Conversion Tables

Note: To convert from A to B, multiply by the entry in the table.

Angular Velocity Conversion

A	B	deg/s	rad/s	rpm	rps
deg/s		1	1.75×10^{-2}	0.167	2.78×10^{-3}
rad/s		57.3	1	9.55	0.159
rpm		6	0.105	1	1.67×10^{-2}
rps		360	6.28	60	1

Force Conversion

A	B	lb _f	N	dyne	oz _f	kg _f	g _f
lb _f		1	4.4482	4.448×10^5	16	0.45359	453.6
N		0.22481	1	100.000	3.5967	0.10197	----
dyne		2.248×10^{-6}	0.00001	1	3.59×10^{-5}	----	980.6
oz _f		0.0625	0.27801	2.78×10^4	1	0.02835	28.35
kg _f		2.205	9.80665	----	35.274	1	1000
g _f		2.205×10^{-3}	----	1.02×10^{-3}	0.03527	0.001	1

Notes:
 lb_f = 1 slug x 1 ft/s²
 N = 1 kg x 1 m/s²
 dyne = 1 g x 1 cm/s²

Length Conversion

A	B	in	ft	μm	mm	cm	m
in		1	0.0833	2.54×10^4	25.4	2.54	0.0254
ft		12	1	3.048×10^5	304.8	30.48	0.3048
μm		3.937×10^{-5}	3.281×10^{-6}	1	0.001	1.0×10^{-4}	1.0×10^{-6}
mm		0.03937	0.00328	1000	1	0.1	0.001
cm		0.3937	0.03281	1.0×10^4	10	1	0.01
m		39.37	3.281	1.0×10^6	1000	100	1

Power Conversion

A	B	Watts	kW	Horsepower (English)	Horsepower (metric)	ft-lb/s	in-lb/s
Watts		1	1×10^{-3}	1.34×10^{-3}	1.36×10^{-3}	0.74	8.88
kW		1000	1	1.34	1.36	738	8880
Horsepower (English)		746	0.746	1	1.01	550	6600
Horsepower (metric)		736	0.736	0.986	1	543	6516
ft-lb/s		1.35	1.36×10^{-3}	1.82×10^{-3}	1.84×10^{-3}	1	12
in-lb/s		0.113	1.13×10^{-4}	1.52×10^{-4}	1.53×10^{-4}	8.3×10^{-2}	1

Conversion Tables CONTINUED

Note: To convert from A to B, multiply by the entry in the table.

Mass Conversion

A	B	g	kg	slug	lb _m	oz _m
g		1	0.001	6.852×10^{-5}	2.205×10^{-3}	0.03527
kg		1000	1	6.852×10^{-2}	2.205	35.274
slug		14590	14.59	1	32.2	514.72
lb _m		453.6	0.45359	0.0311	1	16
oz _m		28.35	0.02835	1.94×10^{-3}	0.0625	1

Linear Velocity Conversion

A	B	in/min	ft/min	in/s	ft/s	mm/s	m/s
in/min		1	0.0833	0.0167	1.39×10^{-3}	0.42	4.2×10^{-4}
ft/min		12	1	.2	0.0167	5.08	5.08×10^{-3}
in/s		60	5	1	0.083	25.4	0.0254
ft/s		720	60	12	1	304.8	0.3048
cm/s		23.62	1.97	0.3937	0.0328	10	0.01
m/s		2362.2	196.9	39.37	3.281	1000	1

Rotary Inertia Conversion

A	B	lb-in-s ²	lb-ft-s ²	lb-in ²	lb-ft ²	oz-in ²	oz-in-s ²	g-cm ²	kg-cm ²	g-cm-s ²	kg-cm-s ²	kg-m ²
lb-in-s ²		1	0.083	386.1	2.68	6177	16	$1.13E^{-6}$	1130	1152	1.152	0.113
lb-ft-s ²		12.0	1	4633	32.2	$7.41E^{-4}$	192	$1.36E^{-7}$	$1.36E^{-4}$	$1.38E^{-4}$	13.83	1.36
lb-in ²		0.0026	$2.16E^{-4}$	1	0.0069	16	0.041	2936	2.93	2.98	0.0030	$2.93E^{-4}$
lb-ft ²		0.373	0.031	144	1	2304	5.97	$4.21E^{-5}$	421.4	429.7	0.430	0.0421
oz-in ²		$1.62E^{-4}$	$1.35E^{-5}$	0.0625	$4.34E^{-4}$	1	0.0026	182.9	0.183	0.187	$1.87E^{-4}$	$1.83E^{-5}$
oz-in-s ²		0.063	0.0052	24.13	0.168	386.1	1	$7.06E^{-4}$	70.62	72.0	0.072	0.007
g-cm ²		$8.85E^{-7}$	$7.38E^{-8}$	$3.42E^{-4}$	$2.37E^{-6}$	0.0055	$1.42E^{-5}$	1	0.001	0.001	$1.02E^{-6}$	$1.00E^{-7}$
kg-cm ²		$8.85E^{-4}$	$7.38E^{-5}$	0.342	0.0024	5.47	0.014	1000	1	1.02	0.001	0.0001
g-cm-s ²		$8.68E^{-4}$	$7.23E^{-5}$	0.335	0.0023	5.36	0.014	981	0.981	1	0.001	$9.73E^{-5}$
kg-cm-s ²		0.868	0.072	335.1	2.33	5362	13.89	$9.81E^{-5}$	981	1000	1	0.0973
kg-m ²		8.85	0.738	3417.74	23.734	54683.91	141.6	$1.00E^{-7}$	10000	10282	10.282	1

Torque Conversion

A	B	lb-in	lb-ft	oz-in	g-cm	kg-cm	kg-m	N-m
lb-in		1	0.083	16	1152	1.152	0.012	0.113
lb-ft		12	1	192	$1.38E^{-4}$	13.83	0.138	1.356
oz-in		0.063	$5.21E^{-3}$	1	72.01	0.072	$7.21E^{-4}$	$7.06E^{-3}$
g-cm		$8.68E^{-4}$	$7.23E^{-5}$	0.014	1	0.001	$1.0E^{-6}$	$9.81E^{-5}$
kg-cm		0.868	0.072	13.89	1000	1	0.01	0.098
kg-m		86.80	7.23	1389	$1.0E^{-6}$	100	1	9.81
N-m		8.851	0.738	141.6	$1.02E^{-4}$	10.20	0.102	1

Glossary

Abbe error – The positioning error resulting from angular motion and an offset between the measuring device and the point of interest.

Abbe offset – The value of the offset between the measuring device and the point of interest.

Absolute move – A move referenced to a known point or datum.

Absolute programming – A positioning coordinate reference where all positions are specified relative to a reference or “home” position.

AC brushless servo – A servomotor with stationary windings in the stator assembly and permanent magnet rotor. AC brushless generally refers to a sinusoidally wound motor (such as BM series) to be commutated via sinusoidal current waveform. (see DC Brushless Servo)

Acceleration – The change in velocity as a function of time.

Accuracy – An absolute measurement defining the difference between actual and commanded position.

Accuracy grade – In reference to an encoder grating, accuracy grade is the tolerance of the placement of the graduations on the encoder scale.

ASCII – American Standard Code for Information Interchange. This code assigns a number to each numeral and letter of the alphabet. Information can then be transmitted between machines as a series of binary numbers.

Axial runout – Positioning error of the rotary stage in the vertical direction when the tabletop is oriented in the horizontal plane. Axial runout is defined as the total indicator reading on a spherical ball positioned 50 mm above the tabletop and centered on the axis of rotation.

Axis of rotation – A center line about which rotation occurs.

Back emf, K_{emf} – The voltage generated when a permanent magnet motor is rotated. This voltage is proportional to motor speed and is present whether the motor windings are energized or not.

Backlash – A component of bidirectional repeatability, it is the non-responsiveness of the system load to reversal of input command.

Ball screw – A precision device for translating rotary motion into linear motion. A lead screw is a lower cost, lower

performance device performing the same function. Unit consists of an externally threaded screw and an internally threaded ball nut.

Ball screw lead – The linear distance a carriage will travel for one revolution of the ball screw (lead screw).

Bandwidth – A measurement, expressed in frequency (hertz), of the range which an amplifier or motor can respond to an input command from DC to -3dB on a frequency sweep.

Baud rate – The number of bits transmitted per second on a serial communication channel such as RS-232 or modem.

BCD – Binary Coded Decimal - A number system using four bits to represent 0-F (15).

Bearing – A support mechanism allowing relative motion between two surfaces loaded against each other. This can be a rotary ball bearing, linear slide bearing, or air bearing (zero friction).

Bidirectional repeatability – See Repeatability.

CAM profile – A technique used to perform nonlinear motion that is electronically similar to the motion achieved with mechanical cams.

Cantilevered load – A load not symmetrically mounted on a stage.

Closed loop – A broad term relating to any system where the output is measured and compared to the input. Output is adjusted to reach the desired condition.

CNC – Computer Numerical Control. A computer-based motion control device programmable in numerical word address format.

Coefficient of friction – Defined as the ratio of the force required to move a given load to the magnitude of that load.

Cogging – Nonuniform angular/linear velocity. Cogging appears as a jerkiness, especially at low speeds, and is due to the magnetic poles’ attraction to steel laminations.

Commutation – The action of steering currents to the proper motor phases to produce optimum motor torque/force. In brush-type motors, commutation is done electromechanically via the brushes and commutator. A brushless motor is electronically commutated using a position feedback device such as an encoder or Hall effect devices. Stepping motors are electronically commutated without feedback in an open-loop fashion.

Glossary CONTINUED

Commutation, 6-step – Also referred to as trapezoidal commutation. The process of switching motor phase current based on three Hall effect signals spaced 120 electrical degrees beginning 30 degrees into the electrical cycle. This method is the easiest for commutation of brushless motors.

Commutation, modified 6-step – Also referred to as modified sine commutation. The process of switching motor phase current based on three Hall effect signals spaced 120 electrical degrees beginning at 0 electrical degrees. This method is slightly more difficult to implement than standard 6-step, but more closely approximates the motor's back emf. The result is smoother control and less ripple. Aerotech's BA series self-commutate using this method.

Commutation, sinusoidal – The process of switching motor phase current based on motor position information, usually from an encoder. In this method, the three phase currents are switched in very small increments that closely resemble the motor's back emf. Sinusoidal commutation requires digital signal processing to convert position information into three-phase current values and, consequently, is most expensive to implement. The result, however, is the best possible control. All Aerotech controllers, as well as the BAS series amplifiers, self-commutate using this method.

Coordinated motion – Multi-axis motion where the position of each axis is dependent on the other axis, such that the path and velocity of a move can be accurately controlled. Drawing a circle requires coordinated motion.

Critical speed – A term used in the specification of a lead screw or ball screw indicating the maximum rotation speed before resonance occurs. This speed limit is a function of the screw diameter, distance between support bearings, and bearing rigidity.

Current command – Motor driver or amplifier configuration where the input signal is commanding motor current directly, which translates to motor torque/force at the motor output. Brushless motors can be commutated directly from a controller that can output current phase A and B commands.

Current, peak – An allowable current to run a motor above its rated load, usually during starting conditions. Peak current listed on a data sheet is usually the highest current safely allowed to the motor.

Current, rms – Root Mean Square. Average of effective currents over an amount of time. This current is calculated based on the load and duty cycle of the application.

Cycle – When motion is repeated (move and dwell) such as repetitive back-and-forth motion.

DC brushless servo – A servomotor with stationary windings in the stator assembly and permanent magnet rotor. (See AC Brushless Servo)

Deceleration – The change in velocity as a function of time.

Duty cycle – For a repetitive cycle, the ratio of "on" time to total cycle time used to determine a motor's rms current and torque/force.

Dwell time – Time in a cycle at which no motion occurs. Used in the calculation of rms power.

Efficiency – Ratio of input power vs. output power.

Electronic gearing – Technique used to electrically simulate mechanical gearing. Causes one closed loop axis to be slaved to another open or closed loop axis with a variable ratio.

Encoder marker – Once-per-revolution signal provided by some incremental encoders to accurately specify a reference point within that revolution. Also known as Zero Reference Signal or Index Pulse.

Encoder resolution – Measure of the smallest positional change which can be detected by the encoder. A 1000-line encoder with a quadrature output will produce 4000 counts per revolution.

Encoder, incremental – Position encoding device in which the output is a series of pulses relative to the amount of movement.

Feedback – Signal that provides process or loop information such as speed, torque, and position back to the controller to produce a closed-loop system.

Flatness (of travel) – Measure of the vertical deviation of a stage as it travels in a horizontal plane.

Force, continuous – The value of force that a particular motor can produce in a continuous stall or running (as calculated by the rms values) condition.

Force, peak – The maximum value of force that a particular motor can produce. When sizing for a specific application, the peak force is usually that required during acceleration and deceleration of the move profile. The peak force is used in conjunction with the continuous force and duty cycle to calculate the rms force required by the application.

Friction – The resistance to motion between two surfaces in contact with each other.

Glossary CONTINUED

G.P.I.B. – A standard protocol, analogous to RS-232, for transmitting digital information. The G.P.I.B. interface (IEEE-488) transmits data in parallel instead of serial format. (See IEEE-488)

Gain – Comparison or ratio of the output signal and the input signal. In general, the higher the system gain, the higher the response.

Grating period – Actual distance between graduations on an encoder.

Hall effect sensors – Feedback device (HED) used in a brushless servo system to provide information for the amplifier to electronically commutate the motor.

HED – Hall Effect Device. (See Hall effect sensors)

HMI – Human Machine Interface. Used as a means of getting operator data into the system. (See MMI)

Home – Reference position for all absolute positioning movements. Usually defined by a home limit switch and/or encoder marker.

Home switch – A sensor used to determine an accurate starting position for the home cycle.

Hysteresis – A component of bidirectional repeatability. Hysteresis is the deviation between actual and commanded position and is created by the elastic forces in the drive systems.

I/O – Input/Output. The reception and transmission of information between control devices using discrete connection points.

IEEE-488 – A set of codes and formats to be used by devices connected via a parallel bus system. This standard also defines communication protocols that are necessary for message exchanges, and further defines common commands and characteristics. (See G.P.I.B.)

Incremental move – A move referenced from its starting point (relative move).

Inertia – The physical property of an object to resist changes in velocity when acted upon by an outside force. Inertia is dependent upon the mass and shape of an object.

Lead error – The deviation of a lead screw or ball screw from its nominal pitch.

Lead screw – A device for translating rotary motion into linear motion. Unit consists of an externally threaded screw and an internally threaded carriage (nut). (See Ball screw)

Life – The minimum rated lifetime of a stage at maximum payload while maintaining positioning specifications.

Limit switch – A sensor used to determine the end of travel on a linear motion assembly.

Limits – Sensors called limits that alert the control electronics that the physical end of travel is being approached and motion should stop.

Linear motor – A motor consisting of two parts, typically a moving coil and stationary magnet track. When driven with a standard servo amplifier, it creates a thrust force along the longitudinal axis of the magnet track.

Load carrying capability – The maximum recommended payload that does not degrade the listed specifications for a mechanical stage.

Master-slave – Type of coordinated motion control where the master axis position is used to generate one or more slave axis position commands.

MMI – Man Machine Interface used as a means of getting operator data into the system. (See HMI)

Motion profile – A method of describing a process in terms of velocity, time, and position.

Motor brush – The conductive element in a DC brush-type motor used to transfer current to the internal windings.

Motor, brushless – Type of direct current motor that utilizes electronic commutation rather than brushes to transfer current.

Motor, stepping – Specialized motor that allows discrete positioning without feedback. Used for noncritical, low power applications, since positional information is easily lost if acceleration or velocity limits are exceeded.

NC – Numerical Control. Automated equipment or process used for contouring or positioning. (See CNC)

NEMA – National Electrical Manufacturer's Association. Sets standards for motors and other industrial electrical equipment.

Non-volatile memory – Memory in a system that maintains information when power is removed.

Open collector – A signal output that is performed with a transistor. Open collector output acts like a switch closure with one end of the switch at circuit common potential and the other end of the switch accessible.

Open loop – Control circuit that has an input signal only, and thus cannot make any corrections based on external influences.

Glossary CONTINUED

Operator interface – Device that allows the operator to communicate with a machine. A keyboard or thumbwheel is used to enter instructions into a machine. (See HMI or MMI)

Optical encoder – A linear or angular position feedback device using light fringes to develop position information.

Opto-isolated – System or circuit that transmits signal with no direct electrical connections, using photoelectric coupling between elements.

Orthogonality – The condition of a surface or axis which is perpendicular (offset 90 degrees) to a second surface or axis. Orthogonality specification refers to the error from 90 degrees from which two surfaces of axes are aligned.

Overshoot – In a servo system, referred to the amount of velocity and/or position overrun from the input command. Overshoot is a result of many factors including mechanical structure, tuning gains, servo controller capability, and inertial mismatch.

PID – A group of gain terms in classical control theory (Proportional Integral Derivative) used in compensation of a closed-loop system. The terms are optimally adjusted to have the output response equal the input command. Aerotech controllers utilize the more sophisticated PID FVFA loop which incorporates additional terms for greater system performance.

Pitch (of travel) – Angular motion of a carriage around an axis perpendicular to the motion direction and perpendicular to the yaw axis.

Pitch error – Positioning error resulting from a pitching motion.

PLC – Programmable Logic Controller. A programmable device that utilizes “ladder logic” to control a number of input and output discrete devices.

PWM – Pulse Width Modulation. Switch-mode technique used in amplifiers and drivers to control motor current. The output voltage is constant and switched at the bus value (160 VDC with a 115 VAC input line).

Quadrature – Refers to the property of position transducers that allows them to detect direction of motion using the phase relationship of two signal channels. A 1000-line encoder will yield 4000 counts via quadrature.

Radial runout – Positioning error of the rotary stage in the horizontal direction when the tabletop is oriented in the horizontal plane. Radial runout is defined as the total indicator reading on a spherical ball positioned 50 mm above the tabletop and centered on the axis of rotation.

Ramp time – Time it takes to accelerate from one velocity to another.

Range – The maximum allowable travel of a positioning stage.

RDC – Resolver to Digital Converter. Electronic component that converts the analog signals from a resolver (transmitter type) into a digital word representing angular position.

Repeatability – The maximum deviation from the mean (each side) when repeatedly approaching a position. Unidirectional repeatability refers to the value established by moving toward a position in the same direction. Bidirectional repeatability refers to the value established by moving toward a position in the same or opposite direction.

Resolution – The smallest change in distance that a device can measure.

Retroreflector – An optical element with the property that an input light beam is reflected and returns along the same angle as the input beam. Used with laser interferometers.

Roll (of travel) – Angular motion of a carriage around an axis parallel to the motion direction and perpendicular to the yaw axis.

Roll error – Positioning error resulting from a roll motion.

Rotor – The rotating part of a magnetic structure. In a motor, the rotor is connected to the motor shaft.

RS-232C – Industry standard for sending signals utilizing a single-ended driver/receiver circuit. As such, the maximum distance is limited based on the baud rate setting but is typically 50-100 feet. This standard defines pin assignments, handshaking, and signal levels for receiving and sending devices.

RS-274 – Industry standard programming language. Also referred to as G-code machine programming. A command set specific for the machine tool industry that defines geometric moves.

RS-422 – Industry communication standard for sending signals over distances up to 4000 feet. Standard line driver encoder interfaces utilize RS-422 because of the noise immunity.

Runout – The deviation from the desired form of a surface during full rotation (360 degrees) about an axis. Runout is measured as Total Indicated Reading (TIR). For a rotary stage, axis runout refers to the deviation of the axis of rotation from the theoretical axis of rotation.

Glossary CONTINUED

Servo system – Refers to a closed loop control system where a command is issued for a change in position and the change is then verified via a feedback system.

Settling time – Time required for a motion system to cease motion once the command for motion has ended.

Shaft radial load – Maximum radial load that can be applied to the end of the motor shaft at maximum motor speed.

Shaft runout – Deviation from straight line travel.

Slotless – Describes the type of laminations used in a motor that eliminates cogging torque due to magnetic attraction of the rotor to the stator slots.

Stator – Non-rotating part of a magnetic structure. In a motor, the stator usually contains the mounting surface, bearings, and non-rotating windings.

Stiction – Friction encountered when accelerating an object from a stationary position. Static friction is always greater than moving friction, and limits the smallest possible increment of movement.

Straightness of travel – Measure of the side-to-side deviation of a stage as it travels in a horizontal plane.

Torque – Rotary equivalent to force. Equal to the product of the force perpendicular to the radius of motion and distance from the center of rotation to the point where the force is applied.

Torque, continuous – Torque needed to drive a load over a continuous time.

Torque, peak – Maximum amount of torque a motor can deliver when the highest allowable peak currents are applied.

Torque, rms – Root Mean Square (rms) is a mathematical method to determine a steadfast or average torque for a motor.

Torque, stall – The maximum torque without burning out the motor.

Total Indicated Reading (TIR) – The full indicator reading observed when a dial indicator is in contact with the part surface during one full revolution of the part about its axis of rotation.

Tuning – In a servo system, the process of optimizing loop gains (usually PID terms) to achieve the desired response from a stage or mechanism from an input command.

Unidirectional repeatability – See Repeatability

Velocity command – Motor driver or amplifier configuration where the input signal is commanding motor velocity. Motors with analog tachometers are normally driven by this driver configuration.

Wobble – An irregular, non-repeatable rocking or staggering motion of the table top of a rotary stage. Wobble is defined as an angular error between the actual axis of rotation and the theoretical axis of rotation.

Yaw (of travel) – Rotation about the vertical axis, perpendicular to the axis of travel. Angular movement (error) that affects straightness and positioning accuracy.

Yaw error – Positioning error resulting from a yaw motion.